

**6000SLX**

SL-N

# **6000SLX**

## **SL-N**

---

**HYDRAULIC CRAWLER CRANE**



# Contents

<b>Specifications</b>	.....	3-4
<b>Symbols</b>	.....	4
<b>Outline</b>	<ul style="list-style-type: none"> <li>■ Winch Assignment ..... 5</li> <li>■ Dimensions &amp; Main Specifications : Liftcrane ..... 6</li> <li>■ Dimensions &amp; Main Specifications : Luffing Tower ..... 7</li> </ul>	
<b>Liftcrane Heavy Duty Boom</b>	<ul style="list-style-type: none"> <li>■ Boom Combinations ..... 8</li> <li>■ Working Range Diagram ..... 8</li> <li>■ Capacities ..... 9</li> <li>■ Notes ..... 10-11</li> </ul>	
<b>Liftcrane Long Range Boom</b>	<ul style="list-style-type: none"> <li>■ Boom Combinations ..... 12</li> <li>■ Working Range Diagram ..... 12</li> <li>■ Capacities ..... 13</li> <li>■ Notes ..... 14-15</li> </ul>	
<b>Heavy Duty Tip Extension</b>	<ul style="list-style-type: none"> <li>■ Boom Combinations ..... 16</li> <li>■ Working Range Diagram ..... 16</li> <li>■ Capacities ..... 17</li> <li>■ Notes ..... 18</li> </ul>	
<b>Luffing Tower</b>	<ul style="list-style-type: none"> <li>■ Boom Combinations ..... 20</li> <li>■ Working Range Diagram ..... 21-24</li> <li>■ Capacities ..... 25-28</li> <li>■ Notes ..... 29-30</li> </ul>	
<b>Transport Data</b>	.....	31

## Specifications

### Engine

- Model : Isuzu 6WG1
- Type : 4-cycle, water-cooled, direct injection, turbo-charged, diesel engine
- Displacement : 15 681 cc
- Rated Output : 397 kW / 1 800 min<sup>-1</sup>  
(540 ps / 1 800 rpm)
- Fuel Tank : 800 liters
- Electrical System : 24 V D.C., 2 batteries

#### Notes:

- 1 Engine meets Stage / Tier 3 of current smoke emission regulations in Europe, United States and Japan.
- 2 The 397 kW engine horsepower shown above is based on an international engine horsepower rating formula that includes the horsepower necessary for engine alternator drive but excludes engine fan drive.

### Control

- Control System : Control levers operate remote-controlled hydraulic servos that direct oil through six sets of tandem valves to provide comprehensive motion control.
- Control Levers : Ergonomic lever layout enables efficient operation. Joystick lever on left side controls slewing and boom hoist. Arm-chair levers on right side control hoist 1 & 2, luffing jib hoist, travel and long-mast hoist. Main winch levers are equipped with drum rotation sensors.
- Slewing Brake Pedal: Designed to be maintenance free while resisting overheating. Unique brake design of hydraulic oil control system makes it possible to smoothly initial slewing motion, even against the wind.
- Display Panel Design : Graphics on the display panel makes it easy to input the necessary operating conditions and data according to actual lifting and working conditions.

### Hydraulic System

Three variable-displacement axial piston pumps and one fixed-displacement tandem gear pump provide power for independent and combined operations for all functions.

- Hydraulic Reservoir Capacity : 800 liters

### Load Hoist Drums (W1, W2)

Independent bi-directional hydraulic motors provide power through a two-stage planetary reduction gear unit to drive the two main hoisting drums for hoisting and lowering operations.

Cables : 28mm dia. / 800 m long.

### Long Mast Hoist Drum (W3)

A single bi-directional axial piston hydraulic motor powers a 3-stage planetary reduction gear unit that drives the rope drum to either hoist or lower the long mast.

Cables : 28 mm dia.

### Luffing Jib Hoist Drum (W4)

A single bi-directional axial piston hydraulic motor powers a 3-stage planetary reduction gear unit that drives the rope drum to either hoist or lower the luffing jib.

Cables : 28 mm dia.

### Boom Hoist Drum (W5)

Independent bi-directional hydraulic motors provide power through a two-stage planetary reduction gear unit to drive the two main hoisting drums for hoisting and lowering operations.

Cables : 28mm dia. / 800 m long.

## Specifications

### Slewing System

Slewing system is designed so that the three slewing pinions mesh with the external slewing ring gear. With this design, the external slewing gears bears the majority of the slewing torque. The system is designed to be easy to lubricate.

### Counterweight

Standard 160 ton counterweight consists of a 20-ton base weight and 14 cast iron block pieces that all have the same dimensions.

Optional 180-ton weight uses two additional weights in addition to standard counterweight.

### Lower Weight

50-ton weight is standard  
62-ton weight is option

### Side Frames

All welded structures are manufactured from high-strength steel. Each component is equipped with two steel plate hooks to make assembling on lower frame lower. Side frame is secured by removable joint pins provided on the lower frame.

- Shoe width : 1 220 mm wide is standard.  
1 524 mm wide is option.
- Drive unit : 2-track drive unit per side frame.

### Safety Device

- Load Moment Indicator (LMI) : The computerized system helps prevent overloads and provide safe and efficient control. Meets both EN and BS standards.
- Front-end Attachment. Erection Mode : This is an internal function of the Load Moment Indicator (LMI). It gives a warning on the LMI panel that the crane has extended beyond its intended working area. Once the work outside the intended working area is completed, the system returns automatically to resume work in the intended working range.
- Hydraulic Boom Backstops : These stops operate in conjunction with LMI to help prevent backward reaction, especially when operating with short boom lengths or against winds.
- Boom Over-hoist and Over-lowering Limiting Device : This is a combination of two systems designed to enhance operating efficiency. One system is a limit switch that is incorporated into the boom foot to prevent over hoisting. The other is a part of the LMI that prevents over-hoisting or over-lowering the boom. It includes automatic drum braking, hydraulic locks and alarm warnings.
- Drum Locks : Electrically operated pawl locks are provided as standard on all drums.

## Symbols



Capacity



Working Radius



Counterweight



Lower Weight



SL-N



Heavy Duty Boom



Heavy Duty Boom Length



Long Range Boom



Long Range Boom Length



Heavy Duty Tip Extension



Luffing Jib



Luffing Jib Length

## Winch Assignment

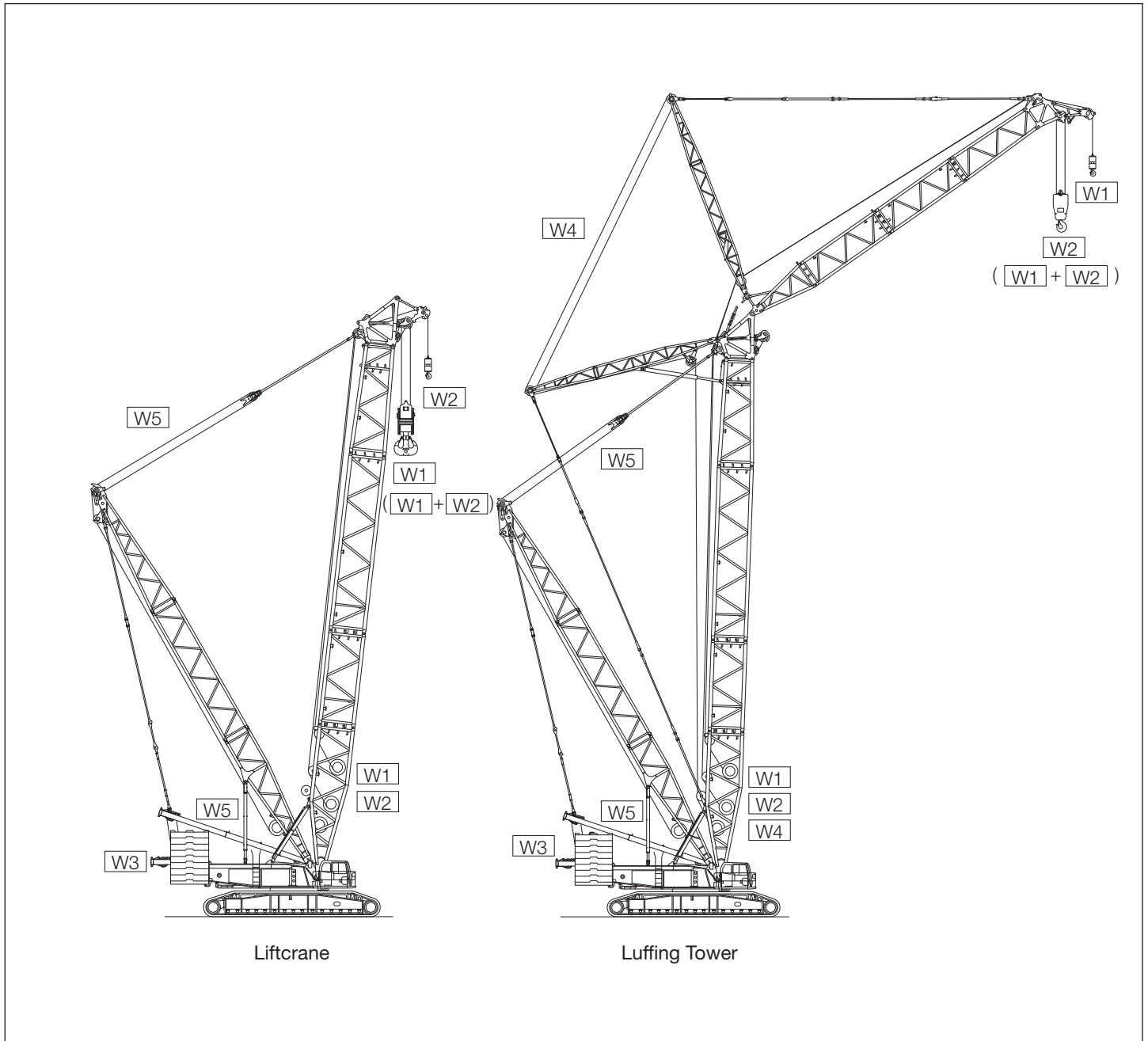

### Hook Blocks

Hook blocks		Mass (kg)
500 t	280 t hook block plus a ten sheaves equalizer block	12 500
280 t	Ten sheaves	7 000
320 t	160 t hook block plus an eight sheaves equalizer block	7 900
160 t	Five sheaves	3 900
65 t	Two sheaves	* 3 000 / 2 000
15 t	Ball hook	950

\* : with auxiliary weights / without auxiliary weights

## Dimensions & Main Specifications : Liftcrane

### ■ Dimensions : Liftcrane

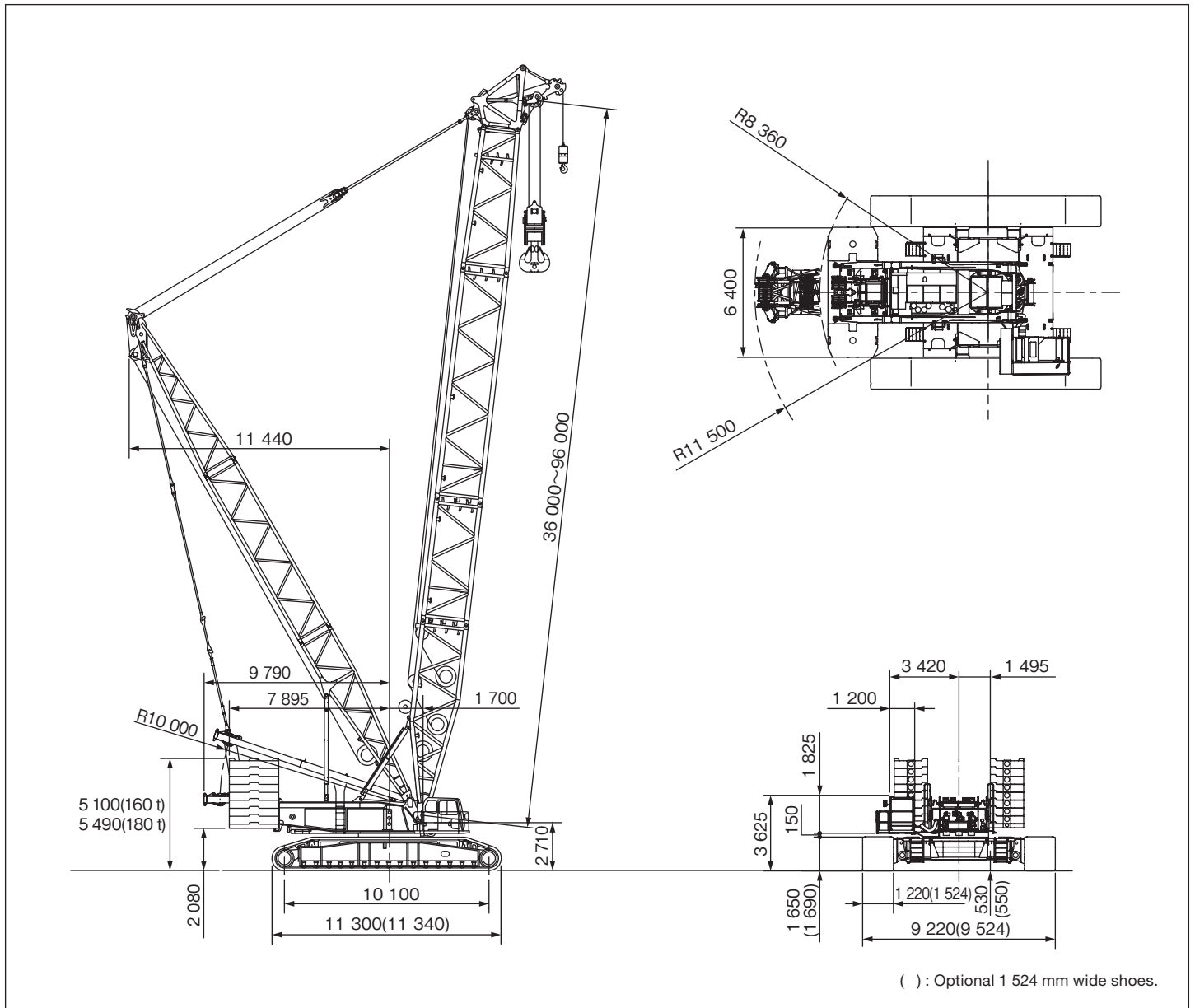

### ■ Main Specification : Liftcrane

Front-end Attachment	Description		Spec.
Liftcrane	Heavy Duty Boom	Max. Lifting Capacity	t X m 428 X 7.3
		Basic Boom Length	m 36
		Max. Boom Length	m 96
	Long Range Boom	Max. Lifting Capacity	t X m 200 X 11.6
		Basic Boom Length	m 78
		Max. Boom Length	m 108
	Line Speed	Load Hoist Drum : W1,W2	m / min 110
		Boom Hoist Drum : W5	m / min 42
	Slewing Speed		min <sup>-1</sup> (rpm) 1.0 (1.0)
	Travel Speed		km / hr 1.5 / 1.3 / 0.6
Ground Pressure*		kPa(kgf / cm <sup>2</sup> ) 138 (1.40)	
Working Mass*		t 435	

\* : Including heavy duty basic boom, 500 t hook block, counterweight(160 t) and optional 1 524 mm wide shoes.

## Dimensions & Main Specifications : Luffing Tower

### ■ Dimensions : Luffing Tower

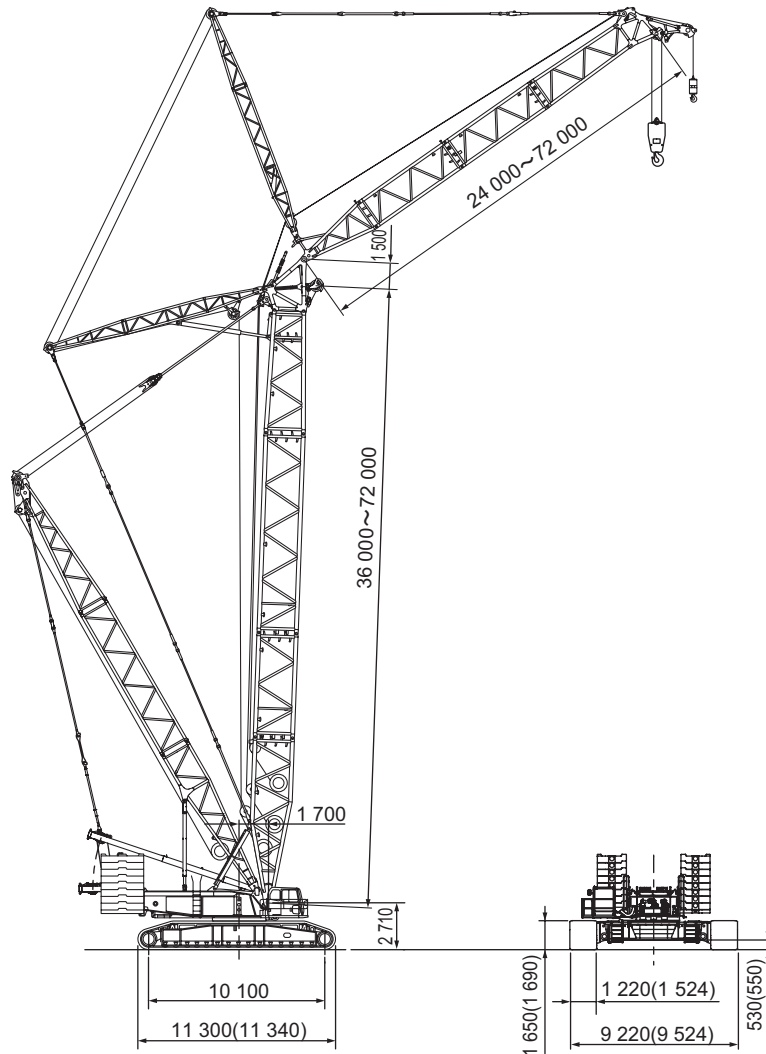

( ) : Optional 1 524 mm wide shoes.

### ■ Main Specification : Luffing Tower

Front-end Attachment	Description		Spec.	
Luffing Tower	Max. Lifting Capacity	t X m	217 X 13.9	
	Basic Tower Length	m	36	
	Max. Tower Length	m	72	
	Basic Luffing Jib Length	m	24	
	Max. Luffing Jib Length	m	72	
	Max. Tower + Luffing Jib Length	m	72+72	
	Line Speed	Load Hoist Drums : W1,W2	m / min	110
		Tower Hoist Drum : W5	m / min	40
		Luffing Jib Hoist Drum : W4	m / min	49
	Slewing Speed	min <sup>-1</sup> (rpm)	1.0 (1.0)	
	Travel Speed	km / hr	1.5 / 1.3 / 0.6	
Ground Pressure*	kPa(kgf / cm <sup>2</sup> )	151 (1.54)		
Working Mass*	t	476		

\* : Including 72 m Tower + 72 m Luffing Jib, counterweight(160 t) and optional 1 524 mm wide shoes.



## Boom Combinations

	Boom Combinations
36 m	HB9.5   H6A   H12A   HR7   HT1.5
42 m	HB9.5   H12A   H12B   HR7   HT1.5
48 m	HB9.5   H6A   H12A   H12B   HR7   HT1.5
54 m	HB9.5   H12A   H12B   H12C   HR7   HT1.5
60 m	HB9.5   H6A   H12A   H12B   H12C   HR7   HT1.5
66 m	HB9.5   H12A   H12B   H12C   HL12B   HR7   HT1.5
72 m	HB9.5   H6A   H12A   H12B   H12C   HL12B   HR7   HT1.5
78 m	HB9.5   H12A   H12B   H12C   HL12B   HL12B   HR7   HT1.5
84 m	HB9.5   H6A   H12A   H12B   H12C   HL12B   HL12B   HR7   HT1.5
90 m	HB9.5   H12A   H12B   H12C   HL12B   HL12B   HL12B   HR7   HT1.5
96 m	HB9.5   H6A   H12A   H12B   H12C   HL12B   HL12B   HL12B   HR7   HT1.5

## Working Range Diagram

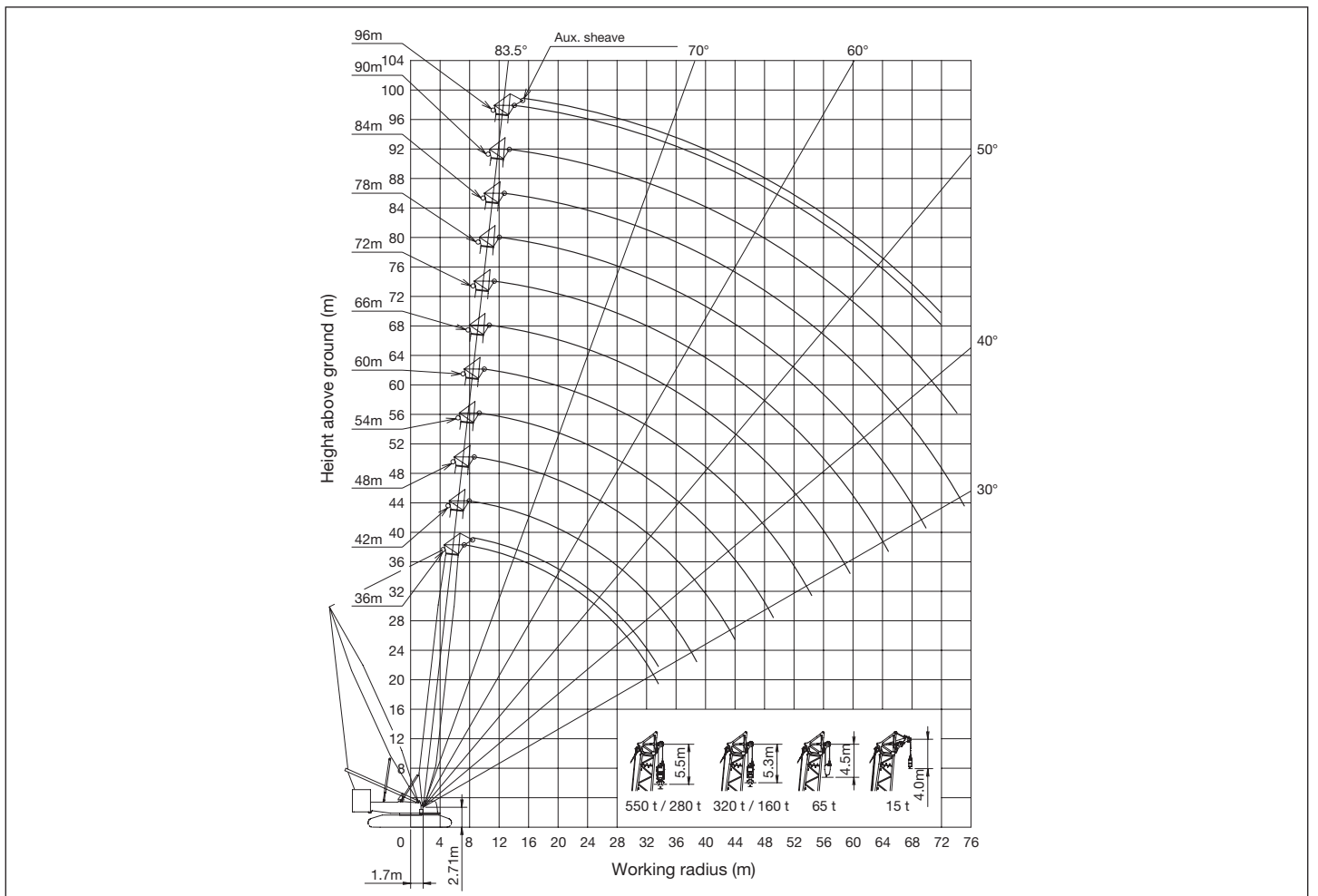







## SL-N H Boom Lifting Capacities

160 t 50 t



(ton)

 (m)  (m)												
	36	42	48	54	60	66	72	78	84	90	96	
7.3	411.0											
8.0	370.0	351.5	292.4 / 8.7	268.1 / 9.4								
10.0	286.5	271.5	251.5	250.5	233.0	216.4 / 10.7	190.0 / 11.4	169.0 / 12.1	159.6 / 12.7	143.4 / 13.4		
14.0	194.0	183.5	182.5	172.5	163.0	162.0	153.5	152.5	144.0	137.0	130.5 / 14.1	
18.0	134.5	134.5	134.0	129.0	123.0	122.5	116.5	115.5	110.0	105.0	103.5	
22.0	99.5	99.5	99.0	98.5	97.5	96.5	92.0	91.0	87.0	83.5	82.0	
26.0	77.5	77.5	76.5	76.0	75.0	75.0	74.0	74.0	70.5	69.5	66.5	
30.0	62.5	62.0	61.0	60.5	59.5	59.5	58.5	58.0	57.5	57.0	54.5	
34.0	52.6 / 33.6	51.3	50.1	49.5	48.5	48.2	47.2	46.9	46.1	45.8	45.2	
38.0		42.9	41.7	41.0	39.9	39.5	38.5	38.2	37.3	37.0	36.3	
42.0		41.5 / 38.8	35.1	34.3	33.1	32.8	31.7	31.3	30.4	30.1	29.3	
46.0			32.3 / 44.0	29.0	27.7	27.3	26.2	25.8	24.8	24.5	23.7	
50.0				25.5 / 49.2	23.3	22.8	21.7	21.2	20.2	19.9	19.1	
54.0					19.7	19.1	17.9	17.4	16.4	16.0	15.2	
58.0					19.3 / 54.4	16.0	14.7	14.2	13.2	12.7	11.8	
62.0						14.9 / 59.6	12.1	11.5	10.4	9.9	9.0	
66.0							10.4 / 64.8	9.1	8.0	7.5	6.5	
70.0								7.2 / 69.9	5.9	5.4	5.0 / 68.8	
72.0									5.0	5.0 / 70.8		

## SL-N H Boom Lifting Capacities

180 t 62 t (OPT.)

(ton)

 (m)  (m)												
	36	42	48	54	60	66	72	78	84	90	96	
7.3	428.0											
8.0	385.5	386.0	324.0 / 8.7	297.5 / 9.4								
10.0	299.0	299.0	279.0	278.5	259.0	240.5 / 10.7	211.5 / 11.4	188.5 / 12.1	178.0 / 12.7	155.5 / 13.4		
14.0	198.0	199.0	198.5	192.5	182.0	181.0	171.5	170.5	161.5	153.5	130.5 / 14.1	
18.0	143.5	144.0	143.0	142.5	138.0	137.0	131.0	130.0	124.0	118.5	117.0	
22.0	111.0	110.5	109.0	109.0	108.0	108.0	104.0	103.0	98.5	95.0	93.0	
26.0	87.0	86.0	84.5	84.0	83.5	84.0	83.5	83.5	80.5	79.5	76.0	
30.0	70.5	69.5	68.0	67.5	66.5	67.0	66.5	66.0	65.5	65.0	63.0	
34.0	59.7 / 33.6	57.6	56.0	55.3	54.2	54.8	54.2	53.8	52.9	52.6	51.9	
38.0		48.6	46.8	46.0	44.9	45.3	44.6	44.2	43.3	43.0	42.2	
42.0		47.1 / 38.8	39.8	38.8	37.6	37.9	37.1	36.7	35.7	35.4	34.6	
46.0			36.9 / 44.0	33.1	31.7	31.9	31.1	30.6	29.6	29.2	28.4	
50.0				29.4 / 49.2	27.0	27.1	26.1	25.6	24.6	24.2	23.3	
54.0					23.2	23.0	22.0	21.5	20.4	20.0	19.1	
58.0					22.8 / 54.4	19.7	18.5	18.0	16.8	16.4	15.4	
62.0						18.5 / 59.6	15.6	15.0	13.8	13.3	12.3	
66.0							13.8 / 64.8	12.4	11.2	10.6	9.6	
70.0								10.3 / 69.9	8.9	8.3	7.3	
74.0									7.0	6.3	5.2	
76.9									6.5 / 75.1	5.0	5.0 / 74.5	



## Notes

1. Capacities included in these charts are the maximum allowable, and are based on machine standing level on firm supporting surface under ideal job conditions.
2. Capacities are in metric tons, and are rated in accordance with European EN13 000 Standards in terms of machine stability and structural strength limitations.
3. Capacities are based on freely suspended loads and make no allowance for such factors as the effect of wind, sudden stopping of loads, supporting surface conditions, and operating speeds. Operator must reduce load ratings to take such conditions into account. Deduction from rated capacities must be made for weight of hook block, weighted ball/hook, sling, spreader bar, or other suspended gear.
4. The maximum rated load of the auxiliary sheave is the value remaining after the 2.0 ton mass of the auxiliary sheave and the mass of the "main hook" attached to the "boom" are deducted from the maximum rated load of the "Heavy Duty Boom Capacities." However, the maximum rated load of the auxiliary sheave is limited to 60 tons. The operating range of the auxiliary sheave is the range that has the maximum rated load of the main hook.
5. If the auxiliary sheave is attached, the maximum rated load of the "main hook" is the value remaining after the 2.0 ton mass of the auxiliary sheave and the mass of the auxiliary hook attached to the auxiliary sheave are deducted from the maximum rated load of the "Heavy Duty Boom Capacities."
6. The "working radius" is the horizontal distance from the slewing center to the center of gravity of a lifted load.
7. The boom tilt angle range is according to the working range diagram.
8. The chart below shows the number of reeled lines and the maximum rated loads. (When the wire rope length is 800 m. )

Hook Capacity (ton)	Hook Weight (ton)	Maximum Rated Load ( ton )																			
		19 X 2Falls	18 X 2Falls	17 X 2Falls	16 X 2Falls	15 X 2Falls	14 X 2Falls	13 X 2Falls	12 X 2Falls	11 X 2Falls	10 X 2Falls	9 X 2Falls	8 X 2Falls	7 X 2Falls	6 X 2Falls	5 X 2Falls					
550	Double-Reeling	12.5	-	-	-	428	412	388	364	339	314	288	262	235	208	180	-	-	-	-	-
320	Double-Reeling	7.9	-	-	-	-	-	-	-	320	314	288	262	235	208	180	151	-	-	-	-
			19 Falls	18 Falls	17 Falls	16 Falls	15 Falls	14 Falls	13 Falls	12 Falls	11 Falls	10 Falls	9 Falls	8 Falls	7 Falls	6 Falls	5 Falls	4 Falls	3 Falls	2 Falls	1 Fall
280	Single-Reeling	7.0	251	240	229	217	206	194	182	170	157	144	131	118	104	-	-	-	-	-	-
160	Single-Reeling	3.9	-	-	-	-	-	-	-	-	157	144	131	118	104	90	76	-	-	-	-
65	Single-Reeling	3.0	-	-	-	-	-	-	-	-	-	-	-	-	-	-	65	61	46	31	-
15	Single-Reeling	1.0	-	-	-	-	-	-	-	-	-	-	-	-	-	-	-	-	-	-	-

9. The chart below shows the operable windings based on the length of each boom.

Hook Capacity (ton)/Boom Length (m)		36	42	48	54	60	66	72	78	84	90	96	
550	Double-Reeling	Max.	16 x 2	14 x 2	12 x 2	11 x 2	9 x 2	9 x 2	8 x 2	7 x 2	6 x 2	6 x 2	-
		Min.	6 x 2	6 x 2	6 x 2	6 x 2	6 x 2	6 x 2	6 x 2	6 x 2	6 x 2	6 x 2	-
320	Double-Reeling	Max.	12 x 2	12 x 2	12 x 2	11 x 2	9 x 2	9 x 2	8 x 2	7 x 2	6 x 2	6 x 2	5 x 2
		Min.	5 x 2	5 x 2	5 x 2	5 x 2	5 x 2	5 x 2	5 x 2	5 x 2	5 x 2	5 x 2	5 x 2
280	Single-Reeling	Max.	19	17	14	13	11	10	9	8	8	7	7
		Min.	7	7	7	7	7	7	7	7	7	7	7
160	Single-Reeling	Max.	11	11	11	11	11	10	9	8	8	7	7
		Min.	5	5	5	5	5	5	5	5	5	5	5
65	Single-Reeling	Max.	5	5	5	5	5	5	5	5	5	5	5
		Min.	2	2	2	2	2	2	2	2	2	2	2
15	Single-Reeling		-	-	-	-	-	-	-	-	-	-	



## Notes

10. If the total mass of the hook mass and the mass of all rigging components is lighter than the mass indicated on this chart, the hook may not lower even when a lowering operation is performed. Please select a hook that can be lowered based on the boom length and number of windings.

Boom Length / Number of reeled lines	1 Fall	2 Falls	3 Falls	4 Falls	5 Falls	6 Falls	7 Falls	8 Falls	9 Falls	10 Falls	11 Falls	12 Falls	13 Falls	14 Falls	15 Falls	16 Falls	17 Falls	18 Falls	19 Falls
36 m	-	2.0	2.0	2.0	2.0	3.9	3.9	3.9	3.9	3.9	3.9	7.0	7.0	7.0	7.0	7.0	7.0	7.0	7.0
42 m	-	2.0	2.0	2.0	2.0	3.9	3.9	3.9	3.9	3.9	3.9	7.0	7.0	7.0	7.0	7.0	7.0	-	-
48 m	-	2.0	2.0	2.0	2.0	3.9	3.9	3.9	3.9	3.9	3.9	7.0	7.0	7.0	-	-	-	-	-
54 m	-	2.0	2.0	2.0	2.0	3.9	3.9	3.9	3.9	3.9	3.9	7.0	7.0	-	-	-	-	-	-
60 m	-	2.0	2.0	2.0	2.0	3.9	3.9	3.9	3.9	3.9	4.1	-	-	-	-	-	-	-	-
66 m	-	2.0	2.0	2.0	2.0	3.9	3.9	3.9	3.9	4.0	-	-	-	-	-	-	-	-	-
72 m	-	2.0	2.0	2.0	2.1	3.9	3.9	3.9	3.9	-	-	-	-	-	-	-	-	-	-
78 m	-	2.0	2.0	2.0	2.3	3.9	3.9	3.9	-	-	-	-	-	-	-	-	-	-	-
84 m	-	2.0	2.0	2.0	2.4	3.9	3.9	4.0	-	-	-	-	-	-	-	-	-	-	-
90 m	-	2.0	2.0	2.1	2.6	3.9	3.9	-	-	-	-	-	-	-	-	-	-	-	-
96 m	-	2.0	2.0	2.2	2.8	3.9	4.0	-	-	-	-	-	-	-	-	-	-	-	-

11. The rated total load when the operation being performed with the rear post support pendant attached is the value remaining when the value in chart below is deducted from the rated total load chart.

Boom Length (m)	36	42	48	54	60	66	72	78	84	90	96
Equivalent Mass (ton)	1.0	1.2	1.5	1.7	2.0	2.2	2.5	2.7	3.0	3.2	3.5



## Boom Combinations

	Boom Combinations
78 m	HB9.5   H6A   H12A   H12B   H12C   HL12B   HR7   LT7.5
84 m	HB9.5   H12A   H12B   H12C   HL12B   HL12B   HR7   LT7.5
90 m	HB9.5   H12A   H12B   H12C   HL12B   HL12B   HR7   L6A   LT7.5
96 m	HB9.5   H12A   H12B   H12C   HL12B   HL12B   HR7   L12A   LT7.5
102 m	HB9.5   H12A   H12B   H12C   HL12B   HL12B   HR7   L6A   L12A   LT7.5
108 m	HB9.5   H12A   H12B   H12C   HL12B   HL12B   HR7   L12A   L12B   LT7.5

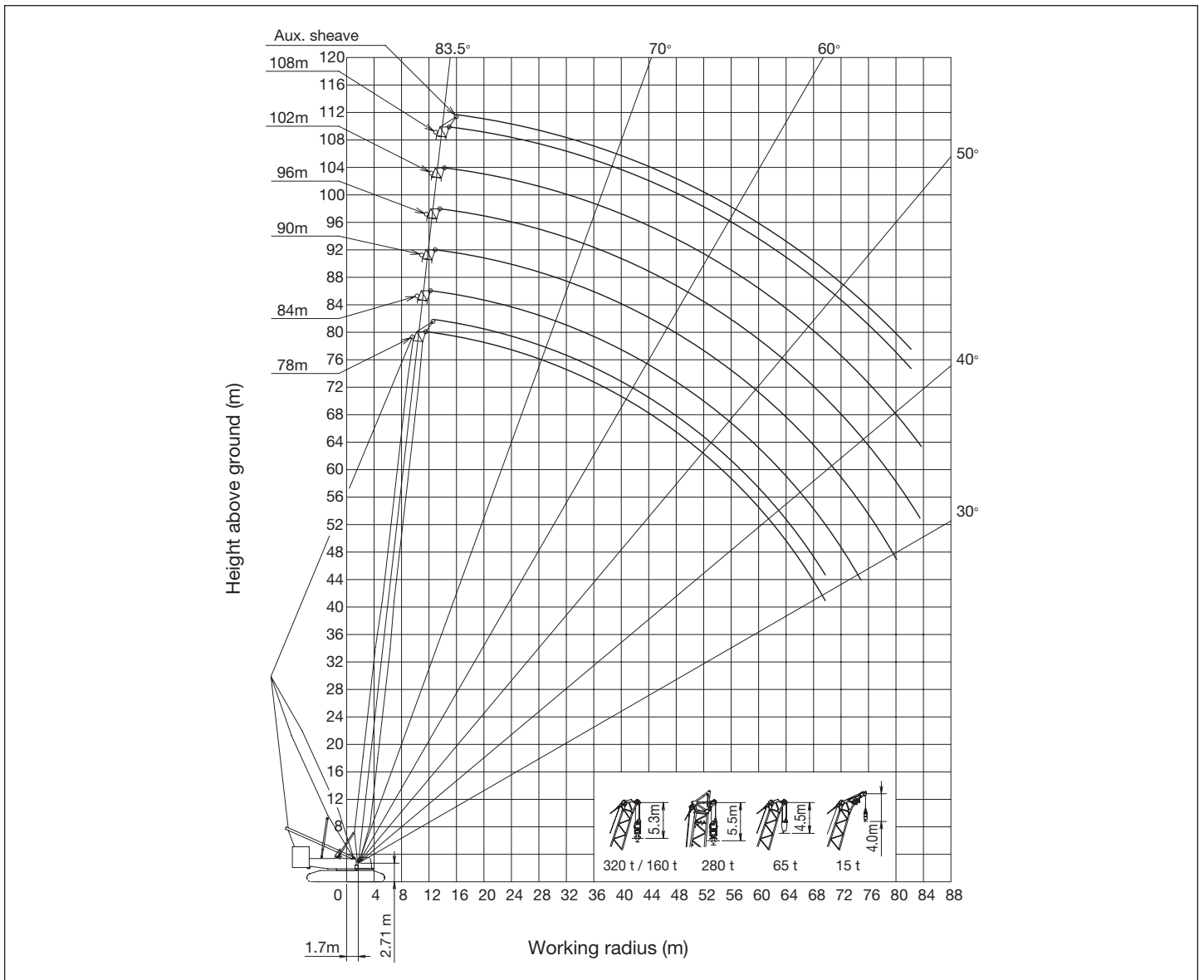

## Working Range Diagram



 SL-N L Boom Lifting Capacities

 160 t  50 t



(ton)

 (m)	78	84	90	96	102	108
 (m)						
11.6	180.0					
12.0	174.0	169.0 / 12.3	153.0 / 12.9	140.0 / 13.6	118.0 / 14.3	98.5 / 15.0
16.0	136.0	130.0	124.0	124.5	117.5	97.5
20.0	106.5	102.5	98.0	98.5	94.5	93.5
24.0	86.5	83.0	82.0	80.5	77.0	77.0
28.0	69.0	68.5	68.0	67.0	64.0	64.0
32.0	55.5	55.0	55.0	55.5	54.0	54.0
36.0	45.9	45.5	45.0	45.8	45.4	45.3
40.0	38.2	37.8	37.3	38.0	37.6	37.5
44.0	32.1	31.7	31.2	31.8	31.3	31.2
48.0	27.2	26.7	26.1	26.7	26.2	26.1
52.0	23.1	22.6	22.0	22.4	22.0	21.8
56.0	19.6	19.1	18.5	18.9	18.4	18.2
60.0	16.7	16.2	15.5	15.8	15.3	15.1
64.0	14.2	13.6	12.9	13.2	12.7	12.5
68.0	12.1	11.4	10.7	10.9	10.3	10.2
72.0	11.3 / 69.7	9.6	8.7	8.9	8.3	8.1
76.0		8.4 / 74.9	7.0	7.2	6.5	6.3
80.0			5.6	5.6	5.0 / 79.8	5.0 / 79.3
81.8			5.5 / 80.1	5.0		

 SL-N L Boom Lifting Capacities

 180 t  62 t (OPT.)

(ton)

 (m)	78	84	90	96	102	108
 (m)						
11.6	200.0					
12.0	194.0	187.0 / 12.3	156.5 / 12.9	140.0 / 13.6	118.0 / 14.3	98.5 / 15.0
16.0	152.0	145.5	139.0	138.5	117.5	97.5
20.0	119.5	115.0	110.5	110.0	106.0	93.5
24.0	97.5	94.0	93.0	90.0	86.5	86.0
28.0	78.0	77.5	77.5	75.0	72.5	72.5
32.0	63.5	63.0	62.5	63.0	61.5	61.0
36.0	52.8	52.4	51.9	52.1	51.8	51.8
40.0	44.4	44.0	43.4	43.5	43.2	43.1
44.0	37.6	37.2	36.7	36.6	36.3	36.2
48.0	32.2	31.7	31.1	31.0	30.6	30.5
52.0	27.7	27.2	26.5	26.4	26.0	25.8
56.0	23.9	23.3	22.7	22.5	22.0	21.9
60.0	20.6	20.1	19.4	19.1	18.6	18.5
64.0	17.9	17.3	16.6	16.2	15.7	15.5
68.0	15.5	14.9	14.1	13.7	13.1	13.0
72.0	14.7 / 69.7	12.8	12.0	11.5	10.9	10.7
76.0		11.5 / 74.9	10.1	9.6	8.9	8.8
80.0			8.4	7.8	7.2	7.0
84.0			8.4 / 80.1	6.3	5.6	5.4
85.7				5.9 / 85.3	5.0	5.0 / 85.1



## Notes

1. Capacities included in these charts are the maximum allowable, and are based on machine standing level on firm supporting surface under ideal job conditions.
2. Capacities are in metric tons, and are rated in accordance with European EN13 000 Standards in terms of machine stability and structural strength limitations.
3. Capacities are based on freely suspended loads and make no allowance for such factors as the effect of wind, sudden stopping of loads, supporting surface conditions, and operating speeds. Operator must reduce load ratings to take such conditions into account. Deduction from rated capacities must be made for weight of hook block, weighted ball/hook, sling, spreader bar, or other suspended gear.
4. The maximum rated load of the auxiliary sheave is the value remaining after the 1.3 ton mass of the auxiliary sheave and the mass of the "main hook" attached to the "boom" are deducted from the maximum rated load of the "Long Range Boom Capacities." However, the maximum rated load of the auxiliary sheave is limited to 30 tons. The operating range of the auxiliary sheave is the range that has the maximum rated load of the main hook.
5. If the auxiliary sheave is attached, the maximum rated load of the "main hook" is the value remaining after the 1.3 ton mass of the auxiliary sheave and the mass of the auxiliary hook attached to the auxiliary sheave are deducted from the maximum rated load of the "Long Range Boom Capacities."
6. The "working radius" is the horizontal distance from the slewing center to the center of gravity of a lifted load.
7. The boom tilt angle range is according to the working range diagram.
8. The chart below shows the number of reeled lines and the maximum rated loads. (When the wire rope length is 800 m.)

Hook Capacity (ton)		Hook Weight (ton)	Maximum Rated Load ( ton )										
			11 X 2Falls	10 X 2Falls	9 X 2Falls	8 X 2Falls	7 X 2Falls	6 X 2Falls	5 X 2Falls				
320	Double-Reeling	7.9	-	-	-	-	200	180	151	-	-	-	-
			-	-	-	8 Falls	7 Falls	6 Falls	5 Falls	4 Falls	3 Falls	2 Falls	1 Fall
280	Single-Reeling	7.0	-	-	-	118	104	90	-	-	-	-	
160	Single-Reeling	3.9	-	-	-	118	104	90	76	-	-	-	
65	Single-Reeling	3.0	-	-	-	-	-	-	65	61	46	31	
15	Single-Reeling	1.0	-	-	-	-	-	-	-	-	-	-	

9. The chart below shows the operable windings based on the length of each boom.

Hook Capacity (ton)/Boom Length (m)		78	84	90	96	102	108
320	Double-Reeling	Max.	7 x 2	7 x 2	6 x 2	5 x 2	5 x 2
		Min.	5 x 2	5 x 2	5 x 2	5 x 2	5 x 2
280	Single-Reeling	Max.	8	8	7	7	6
		Min.	6	6	6	6	6
160	Single-Reeling	Max.	8	8	7	7	6
		Min.	5	5	5	5	5
65	Single-Reeling	Max.	5	5	5	5	5
		Min.	2	2	2	2	2
15	Single-Reeling	-	-	-	-	-	-



## Notes

10. If the total mass of the hook mass and the mass of all rigging components is lighter than the mass indicated on this chart, the hook may not lower even when a lowering operation is performed.

Please select a hook that can be lowered based on the boom length and number of windings.

Boom Length / Number of reeled lines	1 Fall	2 Falls	3 Falls	4 Falls	5 Falls	6 Falls	7 Falls	8 Falls	9 Falls
78 m	-	2.0	2.0	2.0	2.3	3.9	3.9	3.9	-
84 m	-	2.0	2.0	2.0	2.4	3.9	3.9	4.0	-
90 m	-	2.0	2.0	2.1	2.6	3.9	3.9	-	-
96 m	-	2.0	2.0	2.2	2.8	3.9	-	-	-
102 m	-	2.0	2.0	2.3	3.0	-	-	-	-
108 m	-	2.0	2.0	2.5	-	-	-	-	-

11. The rated total load when the operation being performed with the rear post support pendant attached is the value remaining when the value in chart below is deducted from the rated total load chart.

Boom Length (m)	78	84	90	96	102	108
Equivalent Mass (ton)	0.9	1.1	1.1	1.3	1.2	1.4



## Boom Combinations

Boom Combinations	
66 m	
72 m	
78 m	
84 m	
90 m	
96 m	

## Working Range Diagram

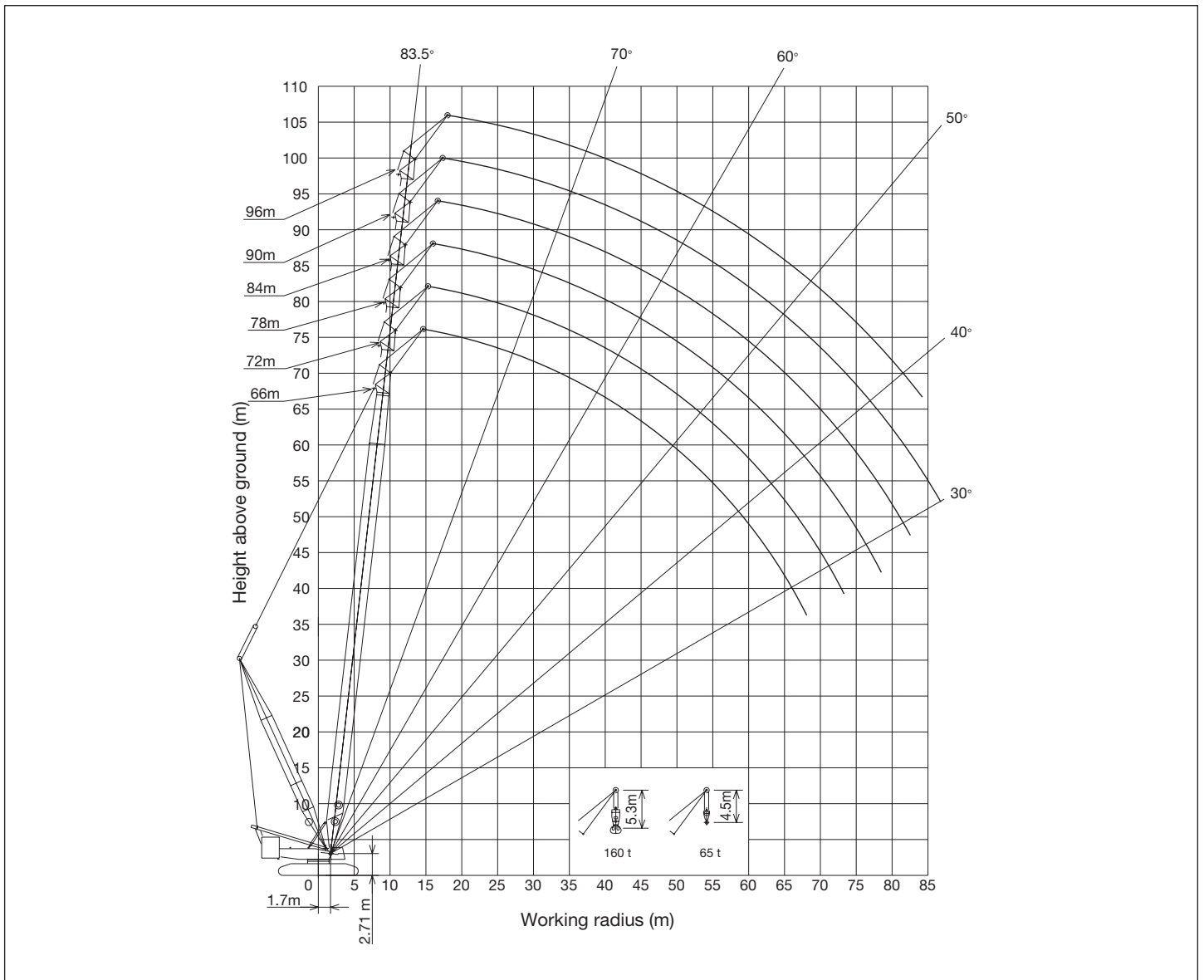







**SL-N 7.62 m Aux. Jib Lifting Capacity (for Windmill)**

 160 t  50 t



(ton)

 (m)	66	72	78	84	90	96
 (m)						
14.7	100.0	100.0 / 15.3				
16.0	100.0	100.0	100.0	100.0 / 16.7	100.0 / 17.4	90.0 / 18.1
20.0	100.0	100.0	100.0	99.5	98.5	90.0
24.0	88.5	87.5	84.0	80.5	79.5	76.0
28.0	73.0	72.0	69.5	66.5	66.0	63.0
32.0	59.5	58.5	58.0	57.0	55.0	52.5
36.0	49.6	48.6	48.0	47.0	46.3	44.7
40.0	41.7	40.6	40.0	38.9	38.3	37.2
44.0	35.3	34.2	33.6	32.5	31.8	30.7
48.0	30.1	29.0	28.4	27.3	26.6	25.4
52.0	25.8	24.6	24.0	22.9	22.2	21.0
56.0	22.1	21.0	20.4	19.2	18.5	17.3
60.0	18.9	17.8	17.2	16.0	15.3	14.1
64.0	16.2	15.0	14.4	13.3	12.5	11.3
68.0	13.8	12.6	12.0	10.9	10.1	8.9
72.0	13.7 / 68.1	10.5	9.9	8.7	8.0	6.8
76.0		9.9 / 73.3	8.0	6.8	6.1	5.0 / 75.7
80.0			6.9 / 78.5	5.1	5.0 / 78.7	
80.4				5.0		

**SL-N 7.62 m Aux. Jib Lifting Capacities (for Windmill)**

 180 t  62 t (OPT.)

(ton)

 (m)	66	72	78	84	90	96
 (m)						
14.7	100.0	100.0 / 15.3				
16.0	100.0	100.0	100.0	100.0 / 16.7	100.0 / 17.4	90.0 / 18.1
20.0	100.0	100.0	100.0	100.0	100.0	90.0
24.0	95.5	97.5	95.0	91.0	90.0	86.5
28.0	83.0	81.5	79.0	76.0	75.0	72.0
32.0	69.0	68.0	67.0	65.5	63.5	60.5
36.0	58.0	57.1	56.7	55.8	54.2	51.9
40.0	49.2	48.3	47.9	47.0	46.5	45.2
44.0	42.2	41.3	40.9	39.9	39.4	38.4
48.0	36.4	35.5	35.1	34.1	33.6	32.6
52.0	31.6	30.7	30.2	29.3	28.7	27.7
56.0	27.5	26.5	26.1	25.1	24.6	23.6
60.0	23.9	23.0	22.6	21.6	21.1	20.0
64.0	20.8	19.9	19.5	18.5	18.0	16.9
68.0	18.0	17.1	16.8	15.8	15.2	14.2
72.0	17.9 / 68.1	14.7	14.3	13.3	12.8	11.8
76.0		13.9 / 73.3	12.1	11.2	10.7	9.6
80.0			10.9 / 78.5	9.2	8.7	7.7
84.0				7.5 / 83.7	6.9	5.9
88.0					5.3	5.0 / 86.2
88.7					5.0	



## Notes

1. Capacities included in these charts are the maximum allowable, and are based on machine standing level on firm supporting surface under ideal job conditions.
2. Capacities are in metric tons, and are rated in accordance with European EN13000 Standards in terms of machine stability and structural strength limitations.
3. Capacities are based on freely suspended loads and make no allowance for such factors as the effect of wind, sudden stopping of loads, supporting surface conditions, and operating speeds. Operator must reduce load ratings to take such conditions into account. Deduction from rated capacities must be made for weight of hook block, weighted ball/hook, sling, spreader bar, or other suspended gear.
4. The maximum rated load of the auxiliary sheave is the value remaining after the mass of the “main hook” attached to the “Heavy Duty Auxiliary Tip Extension” are deducted from the maximum rated load of the “Heavy Duty Auxiliary Tip Extension Capacities.” However, the maximum rated load of the auxiliary sheave is limited to 15 tons. The operating range of the auxiliary sheave is the range that has the maximum rated load of the main hook.
5. If the auxiliary hook is attached to the Auxiliary sheave, the maximum rated load of the “main hook” is the value remaining after the mass of the auxiliary hook are deducted from the maximum rated load of the “Heavy Duty Auxiliary Tip Extension Capacities.”
6. The "working radius" is the horizontal distance from the slewing center to the center of gravity of a lifted load.
7. The boom tilt angle range is according to the working range diagram.
8. The chart below shows the number of reeled lines and the maximum rated loads. (When the wire rope length is 800 m. )

Hook Capacity (ton)		Hook Weight (ton)	Maximum Rated Load ( ton )						
			7 Falls	6 Falls	5 Falls	4 Falls	3 Falls	2 Falls	1 Falls
160	Single-Reeling	3.9	100	90	76	-	-	-	-
65	Single-Reeling	*3.0 / 2.0	-	-	65	61	46	31	-
15	Single-Reeling	1.0	-	-	-	-	-	-	-

\* : With auxiliary weights / Without auxiliary weights

9. The chart below shows the operable windings based on the length of each boom.

Hook Capacity (ton) / Boom Length (m)		66	72	78	84	90	96
160	Single-Reeling	Max.	7	7	7	7	6
		Min.	5	5	5	5	5
65	Single-Reeling	Max.	5	5	5	5	5
		Min.	2	2	2	2	2
15	Single-Reeling	-	-	-	-	-	-

10. If the total mass of the hook mass and the mass of all rigging components is lighter than the mass indicated on this chart, the hook may not lower even when a lowering operation is performed. Please select a hook that can be lowered based on the boom length and number of windings.

Boom Length / Number of reeled lines	1 Fall	2 Falls	3 Falls	4 Falls	5 Falls	6 Falls	7 Falls
66 m	1.0	2.0	2.0	2.0	2.0	3.9	3.9
72 m	1.0	2.0	2.0	2.0	2.1	3.9	3.9
78 m	1.0	2.0	2.0	2.0	2.3	3.9	3.9
84 m	1.0	2.0	2.0	2.0	2.4	3.9	3.9
90 m	1.0	2.0	2.0	2.1	2.6	3.9	3.9
96 m	1.0	2.0	2.0	2.2	2.8	3.9	-

11. The rated total load when the operation being performed with the rear post support pendant attached is the value remaining when the value in chart below is deducted from the rated total load chart.

Boom Length (m)	66	72	78	84	90	96
Equivalent Mass (ton)	2.2	2.5	2.7	3.0	3.2	3.5





## Boom Combinations

Tower Combinations	
36 m	
42 m	
48 m	
54 m	
60 m	
66 m	
72 m	

Jib Combinations	
24 m	
30 m	
36 m	
42 m	
48 m	
54 m	
60 m	
66 m	
72 m	

## Boom Combinations

	24 m	30 m	36 m	42 m	48 m	54 m	60 m	66 m	72 m
36 m	⊙	⊙	⊙	⊙	⊙	⊙	⊙	⊙	⊙
42 m	⊙	⊙	⊙	⊙	⊙	⊙	⊙	⊙	⊙
48 m	⊙	⊙	⊙	⊙	⊙	⊙	⊙	⊙	⊙
54 m	⊙	⊙	⊙	⊙	⊙	⊙	⊙	⊙	⊙
60 m	⊙	⊙	⊙	⊙	⊙	⊙	⊙	⊙	⊙
66 m	×	⊙	⊙	⊙	⊙	⊙	⊙	⊙	⊙
72 m	×	×	⊙	⊙	⊙	⊙	⊙	⊙	⊙

\*The above-mentioned signs are as follows.

⊙ : Possible at 86° - 65°   ○ : Possible at 86° - 75°   × : No setting

# Working Range Diagram

 Tower length 36 m

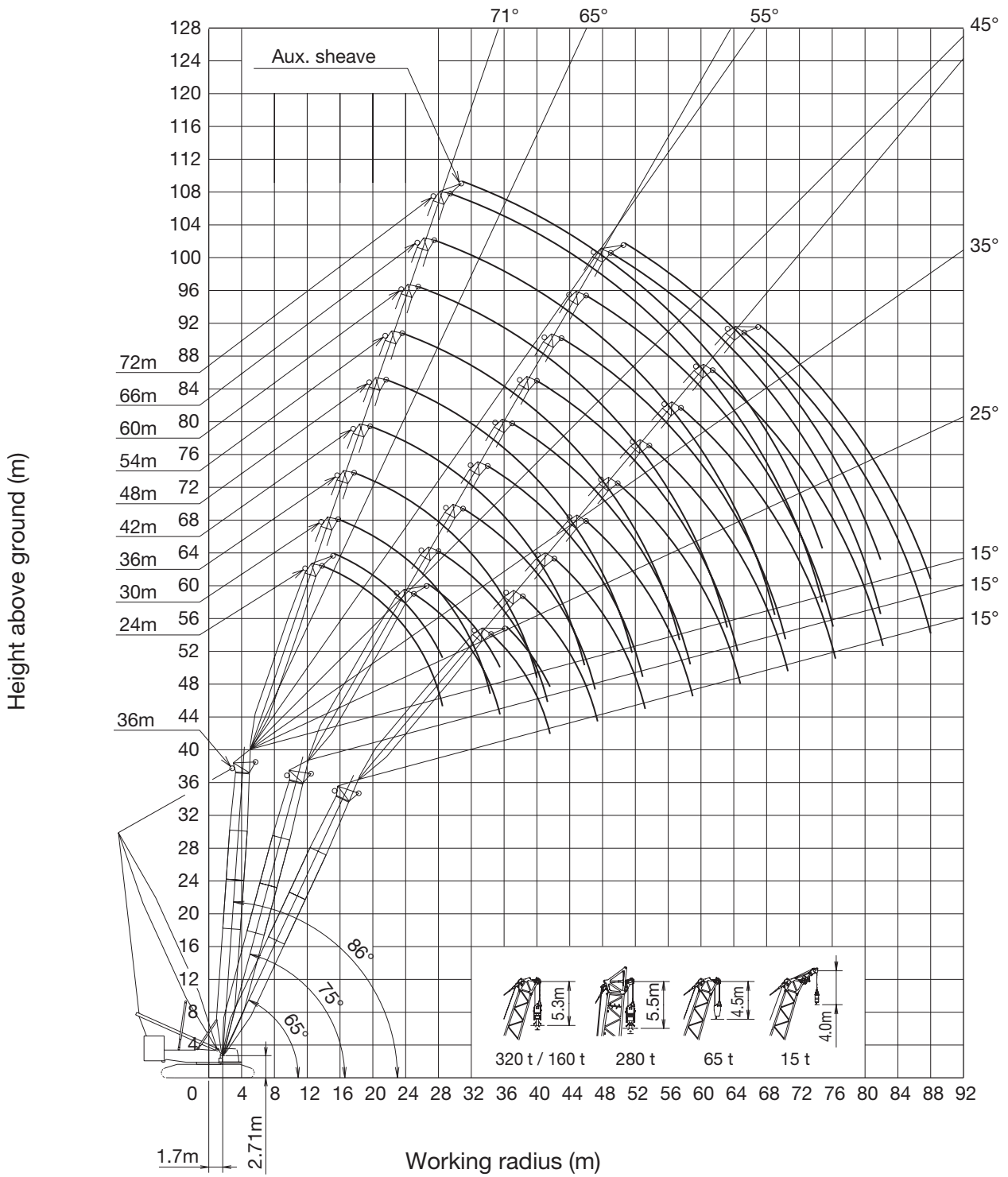





## Working Range Diagram

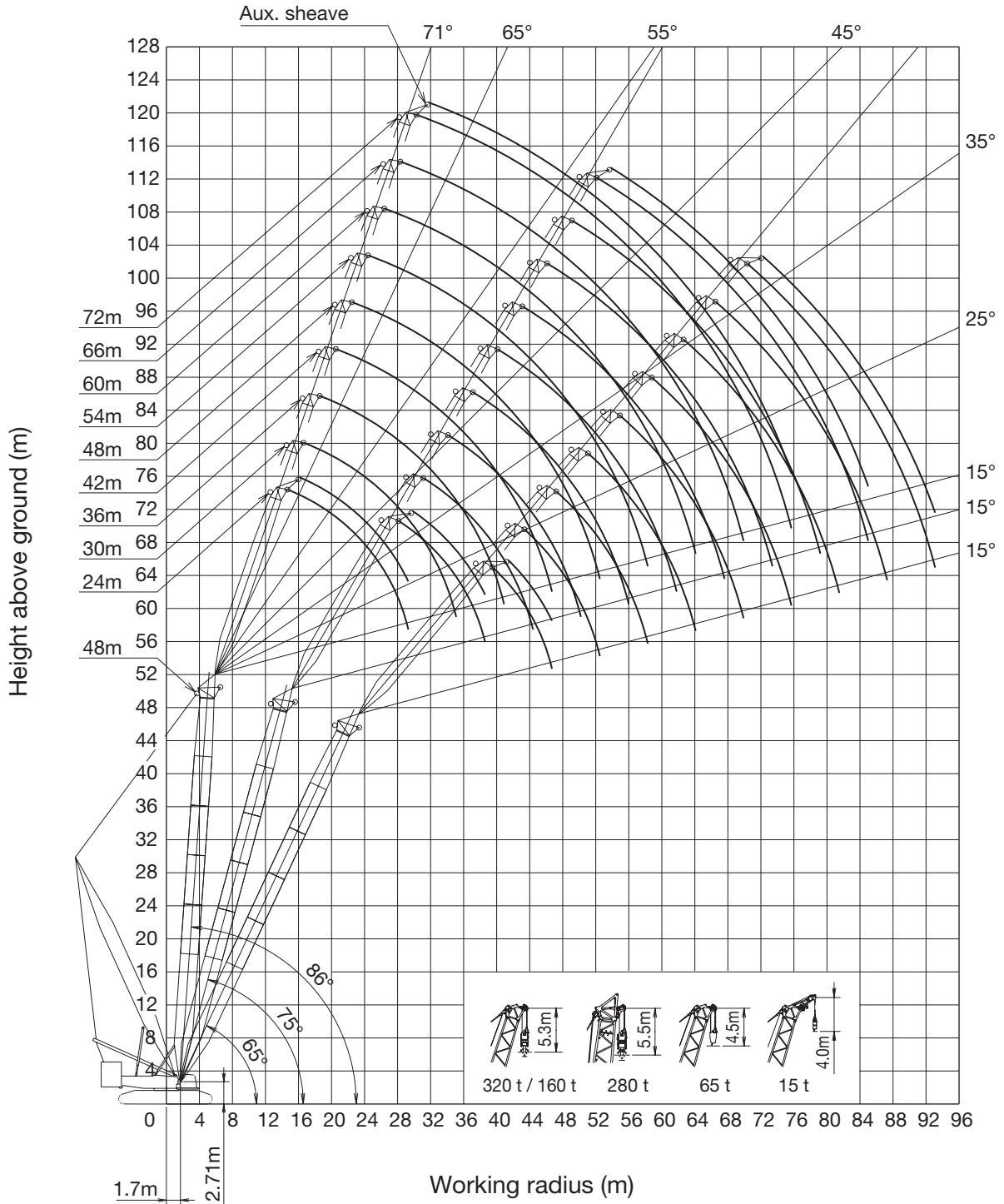

Tower length 48 m



# Working Range Diagram

 Tower length 60 m

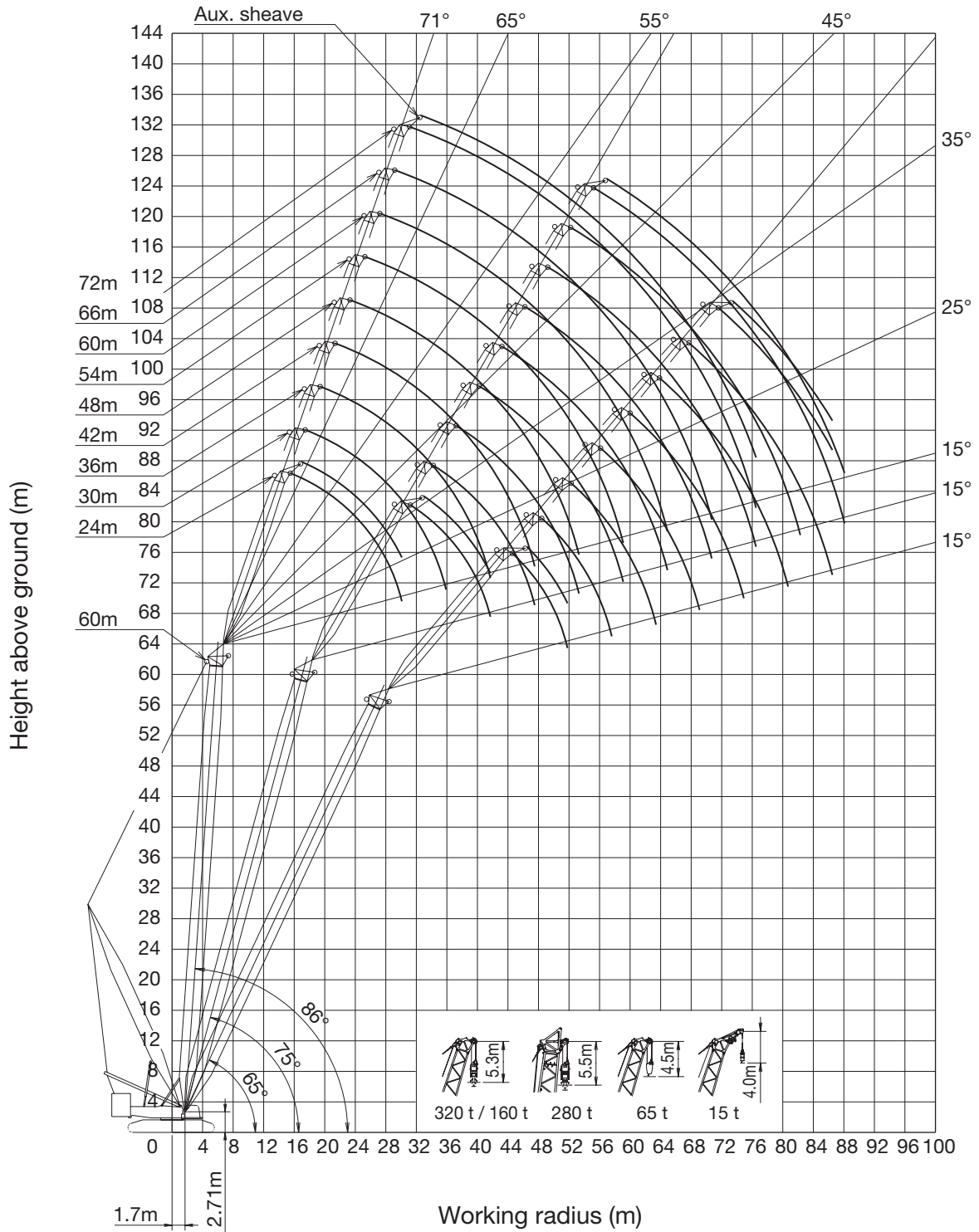





## Working Range Diagram

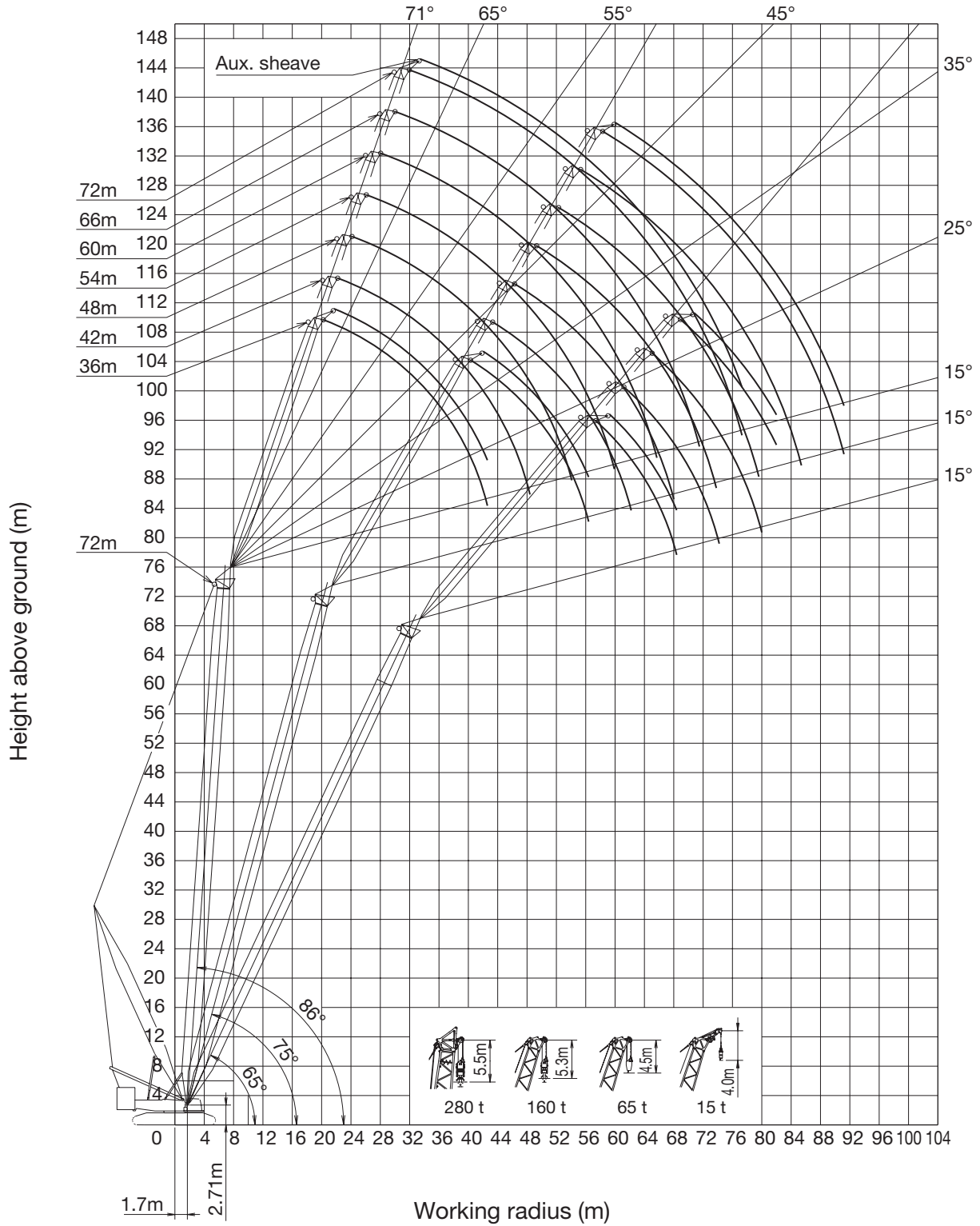

Tower length 72 m





 SL-N Luffing Jib Capacities

 36 m  160 t  50 t w / o Heavy head sheave block

(ton)

 (m)	24 m			36 m			48 m			60 m			72 m		
	86°	75°	65°	86°	75°	65°	86°	75°	65°	86°	75°	65°	86°	75°	65°
13.9	208.2														
14.0	206.5														
16.0	178.4			156.6 / 17.8											
18.0	154.8			154.2											
20.0	133.9			133.3			118.2 / 21.7								
22.0	117.8			117.1			116.0								
24.0	104.8	89.7 / 25.0		104.2			103.1			93.7 / 25.6					
26.0	94.3	85.2		93.7			92.5			91.8					
28.0	85.5	77.2		84.9			83.7			83.0			74.2 / 29.5		
30.0	83.4 / 28.5	70.4		77.5	66.2 / 31.0		76.3			75.5			73.5		
34.0		59.6	52.8 / 34.5	65.7	58.4		64.4	50.5 / 37.0		63.6			62.7		
38.0		56.3 / 35.5	46.3	56.7	50.3		55.4	48.6		54.5			53.6		
42.0			40.9 / 41.6		43.9	38.6 / 42.2	48.3	42.2		47.4	39.8 / 43.0		46.4		
46.0					38.7	34.2	42.6	37.0	28.5 / 49.9	41.6	36.0		40.6	31.5 / 49.0	
50.0					37.4 / 47.1	30.3	37.9	32.8	28.4	36.9	31.7		35.9	30.5	
54.0						27.7 / 53.2	36.2 / 51.6	29.3	25.2	32.9	28.1	21.5 / 57.6	31.9	26.9	
58.0								26.3	22.5	29.6	25.1	21.3	28.5	23.9	
62.0								25.8 / 58.7	20.2	26.7	22.5	18.9	25.5	21.3	15.9 / 65.3
66.0									18.8 / 64.8	25.9 / 63.2	20.3	16.9	23.0	19.0	15.5
70.0											18.3	15.1	20.8	17.0	13.7
74.0											18.2 / 70.3	13.6	18.9	15.3	12.2
78.0												12.8 / 76.4	18.5 / 74.8	13.7	10.8
82.0														12.4 / 81.9	9.5
86.0															8.4
88.0															7.9

 48 m  160 t  50 t w / o Heavy head sheave block

(ton)

 (m)	24 m			36 m			48 m			60 m			72 m		
	86°	75°	65°	86°	75°	65°	86°	75°	65°	86°	75°	65°	86°	75°	65°
14.7	193.6														
16.0	176.4														
18.0	153.8			146.0 / 18.6											
20.0	133.1			132.1											
22.0	117.0			116.0			111.0 / 22.5								
24.0	104.1			103.1			102.0								
26.0	93.6			92.6			91.5			82.6 / 26.4					
28.0	84.8	73.0 / 28.2		83.9			82.7			81.4					
30.0	79.8 / 29.3	67.2		76.6			75.4			75.0			65.7 / 30.3		
34.0		56.8		64.8	54.7 / 34.2		63.6			63.2			61.9		
38.0		48.8	39.6 / 39.5	55.8	47.3		54.6	42.0 / 40.2		54.2			52.9		
42.0		47.8 / 38.6	36.3	50.6 / 40.9	41.1		47.5	39.4		47.1			45.8		
46.0			31.9	36.2	28.7 / 47.3		41.8	34.5		41.3	33.6 / 46.2		40.1		
50.0			31.2 / 46.7	32.1	26.4		37.2	30.4		36.6	29.7		35.3	26.2 / 52.2	
54.0				31.9 / 50.2	23.4		34.7 / 52.5	27.0	20.8 / 55.0	32.6	26.3		31.4	24.8	
58.0					20.9			24.1	19.0	29.3	23.4		28.0	21.9	
62.0					20.8 / 58.3			21.8 / 61.8	16.9	26.4	20.9	15.6 / 62.7	25.1	19.4	
66.0									15.0	25.0 / 64.1	18.7	14.1	22.6	17.2	
70.0									13.5 / 69.9		16.8	12.5	20.4	15.3	10.7 / 70.4
74.0											15.4 / 73.4	11.0	18.4	13.7	9.4
78.0												9.8	17.7 / 75.7	12.2	8.2
82.0												8.8 / 81.5		10.9	7.0
86.0														10.0 / 85.0	6.0
90.0															5.1
90.5															5.0



## SL-N Luffing Jib Capacities

60 m 160 t 50 t w / o Heavy head sheave block

(ton)



(m)	24 m			36 m			48 m			60 m			72 m	
	86°	75°	65°	86°	75°	65°	86°	75°	65°	86°	75°	65°	86°	75°
15.5	153.7													
16.0	152.6													
18.0	148.1			116.2 / 19.5										
20.0	132.0			115.5										
22.0	116.0			112.4			85.8 / 23.4							
24.0	103.3			102.3			85.2							
26.0	92.8			91.9			83.1			66.6 / 27.3				
28.0	84.1			83.3			81.1			66.1				
30.0	76.6	59.7 / 31.3		76.0			75.7			64.7			52.5 / 31.2	
34.0	76.3 / 30.1	53.3		64.3	45.3 / 37.3		64.0			61.9			51.2	
38.0		45.8		55.3	44.1		55.0			53.7			49.3	
42.0		40.1 / 41.7	28.8 / 44.6	48.8 / 41.7	38.3		47.9	35.7 / 43.3		46.6			45.4	
46.0			27.5		33.6		42.2	32.7		40.9	27.8 / 49.3		39.7	
50.0			24.2		29.7	20.7 / 52.3	37.5	28.8		36.2	27.2		35.0	
54.0			22.8 / 51.8		26.9 / 53.3	19.6	34.2 / 53.3	25.5		32.3	24.0		31.1	21.6 / 55.3
58.0						17.3		22.8	15.2 / 60.0	28.9	21.2		27.7	19.8
64.0						14.8 / 63.4		19.3	13.4	24.8	17.8		23.6	16.4
66.0								18.8 / 64.9	12.6	24.2 / 64.9	16.8	10.2 / 67.8	22.3	15.4
68.0									11.8		15.9	10.1	21.2	14.5
70.0									11.1		15.0	9.4	20.1	13.6
72.0									10.4		14.2	8.8	19.1	12.8
74.0									9.8		13.4	8.1	18.2	12.0
76.0									9.5 / 74.9		12.7	7.6	17.3	11.3
78.0											12.6 / 76.5	7.0	17.1 / 76.5	10.6
80.0												6.5		10.0
82.0												6.0		9.4
84.0												5.5		8.8
86.0												5.1		8.2
88.0												5.0 / 86.5		7.7
88.1														7.7

72 m 160 t 50 t w / o Heavy head sheave block

(ton)



(m)	36 m			48 m			60 m		72 m	
	86°	75°	65°	86°	75°	65°	86°	75°	86°	75°
20.3	83.8									
22.0	82.0									
24.0	79.9			67.1 / 24.2						
26.0	77.5			65.7						
28.0	75.3			64.2			50.1 / 28.1			
30.0	73.2			62.6			49.1		40.4 / 32.0	
34.0	63.7			59.4			47.0		39.6	
38.0	55.5	38.1 / 40.4		54.5			44.8		38.2	
42.0	48.6	36.0		47.5			42.7		36.6	
46.0	47.6 / 42.6	31.6		41.8	29.3 / 46.4		40.5		35.1	
50.0		27.9		37.1	26.1		35.9	22.7 / 52.4	33.7	
54.0		24.8	14.6 / 57.4	33.2	23.1		32.0	21.5	30.9	
58.0		23.1 / 56.4	14.3	33.1 / 54.1	20.5		28.7	19.0	27.6	17.3 / 58.4
62.0			12.6		18.2	9.4 / 65.1	25.8	16.8	24.7	15.3
66.0			11.0		16.3	9.1	23.5 / 65.7	14.8	22.2	13.4
70.0			10.2 / 68.4		15.4 / 68.0	7.8		13.2	20.0	11.8
74.0						6.7		11.7	18.0	10.3
78.0						5.7		10.3	16.6 / 77.3	9.0
82.0						5.2 / 80.0		9.8 / 79.6		7.8
86.0										6.7
90.0										5.8
91.2										5.5

 SL-N Luffing Jib Capacities

 36 m  180 t  62 t (OPT.) w / o Heavy head sheave block

(ton)

 (m)	24 m			36 m			48 m			60 m			72 m		
	86°	75°	65°	86°	75°	65°	86°	75°	65°	86°	75°	65°	86°	75°	65°
13.9	217.0														
14.0	215.3														
16.0	184.5			164.5 / 17.8											
18.0	160.5			162.5											
20.0	141.8			144.6			126.6 / 21.7								
22.0	126.8			129.5			124.6								
24.0	114.5	100.1 / 25.0		115.3			112.2			102.6 / 25.6					
26.0	104.2	95.2		103.7			101.9			100.9					
28.0	94.6	86.4		94.1			92.9			92.2			74.2 / 29.5		
30.0	91.0 / 28.5	78.9		86.0	74.3 / 31.0		84.8			84.0			73.5		
34.0		67.0	60.0 / 34.5	73.0	65.8		71.8	57.1 / 37.0		71.0			68.6		
38.0		63.3 / 35.5	52.8	63.2	56.7		61.9	55.1		61.0			60.1		
42.0			46.7 / 41.6	59.0 / 40.0	49.6	44.4 / 42.2	54.1	48.0		53.2	45.4 / 43.0		52.2		
46.0				43.9	39.4	47.8	42.3	33.3 / 49.9	46.9	41.2			45.9	36.4 / 49.0	
50.0				42.5 / 47.1	35.1	42.7	37.6	33.2	41.7	36.5			40.6	35.3	
54.0					32.1 / 53.2	40.9 / 51.6	33.6	29.6	37.3	32.5	25.6 / 57.6		36.3	31.3	
58.0							30.3	26.5	33.6	29.2	25.3		32.5	27.9	
62.0							29.8 / 58.7	24.0	30.5	26.3	22.7		29.3	25.1	19.4 / 65.3
66.0								22.4 / 64.8	29.6 / 63.2	23.8	20.4		26.6	22.5	19.1
70.0										21.7	18.4		24.1	20.3	17.1
74.0										21.5 / 70.3	16.7		22.0	18.4	15.3
78.0											15.8 / 76.4	21.6 / 74.8	16.7	13.7	
82.0													15.2 / 81.9	12.4	
86.0														11.1	
88.0														10.6	

 48 m  180 t  62 t (OPT.) w / o Heavy head sheave block

(ton)

 (m)	24 m			36 m			48 m			60 m			72 m		
	86°	75°	65°	86°	75°	65°	86°	75°	65°	86°	75°	65°	86°	75°	65°
14.7	201.9														
16.0	183.4														
18.0	159.6			152.2 / 18.6											
20.0	141.0			139.6											
22.0	126.0			124.7			111.0 / 22.5								
24.0	113.7			112.5			109.1								
26.0	103.4			102.2			100.9			82.6 / 26.4					
28.0	94.0	82.1 / 28.2		93.1			91.9			81.4					
30.0	88.5 / 29.3	75.7		85.0			83.8			79.9			65.7 / 30.3		
34.0		64.2		72.1	62.0 / 34.2		70.9			69.0			63.3		
38.0		55.3	45.8 / 39.5	62.3	53.8		61.1	48.1 / 40.2		59.2			59.2		
42.0		54.1 / 38.6	42.1	56.5 / 40.9	46.9		53.3	45.2		51.4			51.6		
46.0			37.1		41.4	33.8 / 47.3	47.1	39.7		45.2	37.3 / 46.2		45.3		
50.0			36.3 / 46.7		36.9	31.2	42.0	35.2		40.1	33.1		40.1	30.8 / 52.2	
54.0					36.7 / 50.2	27.8	39.2 / 52.5	31.4	25.1 / 55.0	35.8	29.3		35.7	29.2	
58.0						25.0		28.2	23.0	32.2	26.1		32.0	25.9	
62.0						24.8 / 58.3		25.6 / 61.8	20.6	29.1	23.4	18.1 / 62.7	28.9	23.2	
66.0									18.6	27.7 / 64.1	21.1	16.4	26.1	20.8	
70.0									16.9 / 69.9		19.1	14.6	23.7	18.7	14.0 / 70.4
74.0										17.6 / 73.4	13.1	21.6	16.8	12.6	
78.0											11.7	20.8 / 75.7	15.1	11.1	
82.0											10.8 / 81.5		13.7	9.9	
86.0													12.7 / 85.0	8.7	
90.0														7.7	
93.1														7.0	



## SL-N Luffing Jib Capacities

60 m 180 t 62 t (OPT.) w / o Heavy head sheave block

(ton)

(m)	24 m			36 m			48 m			60 m			72 m	
	86°	75°	65°	86°	75°	65°	86°	75°	65°	86°	75°	65°	86°	75°
15.5	153.7													
16.0	152.6													
18.0	148.1			116.2 / 19.5										
20.0	139.7			115.5										
22.0	124.8			112.4			85.8 / 23.4							
24.0	112.6			109.3			85.2							
26.0	102.4			101.3			83.1			66.6 / 27.3				
28.0	93.3			92.5			81.1			66.1				
30.0	85.1	67.7 / 31.3		84.4			79.0			64.7			52.5 / 31.2	
34.0	84.7 / 30.1	60.7		71.6	51.9 / 37.3		69.9			61.9			51.2	
38.0		52.2		61.8	50.6		60.1			59.1			49.3	
42.0		46.0 / 41.7	34.3 / 44.6	54.6 / 41.7	44.1		52.4	39.9 / 43.3		52.4			47.4	
46.0			32.8		38.8		46.2	36.5		46.2	32.7 / 49.3		44.6	
50.0			29.0		34.4	25.2 / 52.3	41.1	32.2		41.0	32.0		39.4	
54.0			27.4 / 51.8		31.4 / 53.3	24.0	37.6 / 53.3	28.6		36.7	28.4		35.1	25.5 / 55.3
58.0						21.4		25.6	17.8 / 60.0	33.0	25.3		31.4	23.5
62.0						19.2		23.0	16.7	29.8	22.7		28.3	20.8
66.0						18.5 / 63.4		21.4 / 64.9	14.9	27.8 / 64.9	20.4	13.6 / 67.8	25.6	18.6
70.0									13.3		18.4	12.7	23.2	16.6
74.0									11.9		16.6	11.3	21.1	14.8
78.0									11.6 / 74.9		15.6 / 76.5	10.0	19.9 / 76.5	13.3
82.0												8.8		11.9
86.0												7.8		10.7
88.1												7.7 / 86.5		10.1

72 m 180 t 62 t (OPT.) w / o Heavy head sheave block

(ton)

(m)	36 m			48 m			60 m			72 m	
	86°	75°	65°	86°	75°	65°	86°	75°	65°	86°	75°
20.3	83.8										
22.0	82.0										
24.0	79.9			67.1 / 24.2							
26.0	77.5			65.7							
28.0	75.3			64.2			50.1 / 28.1				
30.0	73.2			62.6			49.1			40.4 / 32.0	
34.0	63.7			59.4			47.0			39.6	
38.0	55.5	44.1 / 40.4		56.5			44.8			38.2	
42.0	48.9	41.8		50.9			42.7			36.6	
46.0	47.9 / 42.6	36.8		45.8	34.2 / 46.4		40.5			35.1	
50.0		32.7		41.5	30.5		36.9	26.8 / 52.4		33.7	
54.0		29.2	18.7 / 57.4	37.3	27.1		33.9	25.5		32.3	
58.0		27.3 / 56.4	18.4	37.2 / 54.1	24.2		31.3	22.7		31.1	20.9 / 58.4
62.0			16.4		21.7	12.7 / 65.1	29.1	20.2		28.1	18.7
66.0			14.6		19.5	12.3	26.7 / 65.7	18.0		25.4	16.6
70.0			13.6 / 68.4		18.5 / 68.0	10.8		16.1	8.2 / 72.8	23.0	14.7
74.0						9.5		14.5	7.8	20.9	13.0
78.0						8.4		13.0	6.7	19.3 / 77.3	11.6
82.0						7.8 / 80.0		12.5 / 79.6	5.7		10.3
86.0									5.0 / 85.0		9.1
90.0											8.0
91.2											7.7

## Notes

1. Capacities included in these charts are the maximum allowable, and are based on machine standing level on firm supporting surface under ideal job conditions.
2. Capacities are in metric tons, and are rated in accordance with European EN13 000 Standards in terms of machine stability and structural strength limitations. ; the figures surrounded by bold lines are based on factors other than those which would cause a tipping condition.
3. Capacities are based on freely suspended loads and make no allowance for such factors as the effect of wind, sudden stopping of loads, supporting surface conditions, and operating speeds. Operator must reduce load ratings to take such conditions into account. Deduction from rated capacities must be made for weight of hook block, weighted ball/hook, sling, spreader bar, or other suspended gear.
4. The maximum rated load of the auxiliary sheave is the value remaining after the 1.3 ton mass of the auxiliary sheave and the mass of the "luffing jib hook" attached to the "luffing jib" are deducted from the maximum rated load of the "Luffing Jib Capacities." However, the maximum rated load of the auxiliary sheave is limited to 30 tons. The operating range of the auxiliary sheave is the range that has the maximum rated load of the luffing jib hook.
5. If the auxiliary sheave is attached, the maximum rated load of the "luffing jib hook" is the value remaining after the 1.3 ton mass of the auxiliary sheave and the mass of the auxiliary hook attached to the auxiliary sheave are deducted from the maximum rated load of the "Luffing Jib Capacities."
6. If the heavy head sheave block is attached, the maximum rated load of the "luffing jib hook" is the value remaining after the 3.0 ton mass of the heavy head sheave block and the mass of the "luffing boom hook" attached to the heavy head sheave block are deducted from the "Luffing jib Maximum Rated Load" value.
7. The "working radius" is the horizontal distance from the slewing center to the center of gravity of a lifted load
8. Luffing Boom and Luffing Jib tilt angle ranges are according to the working range diagram.
9. The chart below shows the number of reeled lines and the maximum rated loads. (When the wire rope length is 800 m. )

Hook Capacity (ton)		Hook Weight (ton)	Maximum Rated Load ( ton )												
			8 X 2Falls	7 X 2Falls	6 X 2Falls	5 X 2Falls									
320	Double-Reeling	7.9	217	208	180	151	-	-	-	-					
			13 Falls	12 Falls	11 Falls	10 Falls	9 Falls	8 Falls	7 Falls	6 Falls	5 Falls	4 Falls	3 Falls	2 Falls	1 Fall
280	Single-Reeling	7.0	-	-	157	144	131	118	104	90	-	-	-	-	
160	Single-Reeling	3.9	-	-	157	144	131	118	104	90	76	-	-	-	
65	Single-Reeling	3.0	-	-	-	-	-	-	-	-	65	61	46	31	
15	Single-Reeling	1.0	-	-	-	-	-	-	-	-	-	-	-	-	

10. The chart below shows the operable windings based on the length of each boom.

Tower Length (m)		36									
Hook Capacity (ton) / Jib Length (m)		24	30	36	42	48	54	60	66	72	
320	Double-Reeling	Max.	8 x 2	7 x 2	6 x 2	5 x 2	5 x 2	-	-	-	-
		Min.	5 x 2	5 x 2	5 x 2	5 x 2	5 x 2				
280	Single-Reeling	Max.	11	11	10	9	8	8	7	6	-
		Min.	6	6	6	6	6	6	6	6	
160	Single-Reeling	Max.	11	11	10	9	8	8	7	6	5
		Min.	5	5	5	5	5	5	5	5	5
65	Single-Reeling	Max.	5	5	5	5	5	5	5	5	5
		Min.	2	2	2	2	2	2	2	2	2
15	Single-Reeling		-	-	-	-	-	-	-	-	-

Tower Length (m)		48									
Hook Capacity (ton) / Jib Length (m)		24	30	36	42	48	54	60	66	72	
320	Double-Reeling	Max.	7 x 2	6 x 2	6 x 2	5 x 2	5 x 2	-	-	-	-
		Min.	5 x 2	5 x 2	5 x 2	5 x 2	5 x 2				
280	Single-Reeling	Max.	10	9	8	8	7	7	6	6	-
		Min.	6	6	6	6	6	6	6	6	
160	Single-Reeling	Max.	10	9	8	8	7	7	6	6	5
		Min.	5	5	5	5	5	5	5	5	5
65	Single-Reeling	Max.	5	5	5	5	5	5	5	5	5
		Min.	2	2	2	2	2	2	2	2	2
15	Single-Reeling		-	-	-	-	-	-	-	-	-



## Notes

Tower Length (m)		60									
Hook Capacity (ton) / Jib Length (m)		24	30	36	42	48	54	60	66	72	
320	Double-Reeling	Max.	6 x 2	5 x 2	5 x 2	5 x 2	-	-	-	-	-
		Min.	5 x 2	5 x 2	5 x 2	5 x 2					
280	Single-Reeling	Max.	8	8	7	6	6	-	-	-	-
		Min.	6	6	6	6	6				
160	Single-Reeling	Max.	8	8	7	6	6	5	5	-	-
		Min.	5	5	5	5	5	5	5		
65	Single-Reeling	Max.	5	5	5	5	5	5	5	4	4
		Min.	2	2	2	2	2	2	2	2	2
15	Single-Reeling		-	-	-	-	-	-	-	-	-

Tower Length (m)		72							
Hook Capacity (ton) / Jib Length (m)		36	42	48	54	60	66	72	
280	Single-Reeling	Max.	6	-	-	-	-	-	-
		Min.	6						
160	Single-Reeling	Max.	6	5	5	-	-	-	-
		Min.	5	5	5				
65	Single-Reeling	Max.	5	5	5	4	4	3	3
		Min.	2	2	2	2	2	2	2
15	Single-Reeling		-	-	-	-	-	-	-

11. If the total mass of the hook mass and the mass of all rigging components is lighter than the mass indicated on this chart, the hook may not lower even when a lowering operation is performed.

Please select a hook that can be lowered based on the boom length and number of windings.

Tower Length + Luffing Jib Length	1 Fall	2 Falls	3 Falls	4 Falls	5 Falls	6 Falls	7 Falls	8 Falls	9 Falls	10 Falls	11 Falls	12 Falls
60 m	-	2.0	2.0	2.0	2.0	3.9	3.9	3.9	3.9	3.9	4.1	7.0
66 m	-	2.0	2.0	2.0	2.0	3.9	3.9	3.9	3.9	4.0	4.5	-
72 m	-	2.0	2.0	2.0	2.1	3.9	3.9	3.9	3.9	4.4	-	-
78 m	-	2.0	2.0	2.0	2.3	3.9	3.9	3.9	4.2	-	-	-
84 m	-	2.0	2.0	2.0	2.4	3.9	3.9	4.0	-	-	-	-
90 m	-	2.0	2.0	2.1	2.6	3.9	3.9	4.3	-	-	-	-
96 m	-	2.0	2.0	2.2	2.8	3.9	4.0	-	-	-	-	-
102 m	-	2.0	2.0	2.3	3.0	3.9	-	-	-	-	-	-
108 m	-	2.0	2.0	2.5	3.1	-	-	-	-	-	-	-
114 m	-	2.0	2.0	2.6	3.3	-	-	-	-	-	-	-
120 m	-	2.0	2.0	2.8	-	-	-	-	-	-	-	-
126 m	-	2.0	2.1	2.9	-	-	-	-	-	-	-	-
132 m	-	2.0	2.3	-	-	-	-	-	-	-	-	-
138 m	-	2.0	2.4	-	-	-	-	-	-	-	-	-
144 m	-	2.0	2.5	-	-	-	-	-	-	-	-	-

## SL Attachments

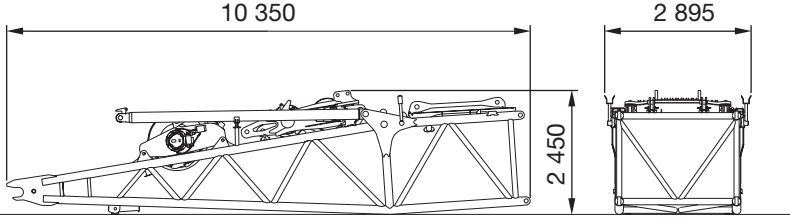
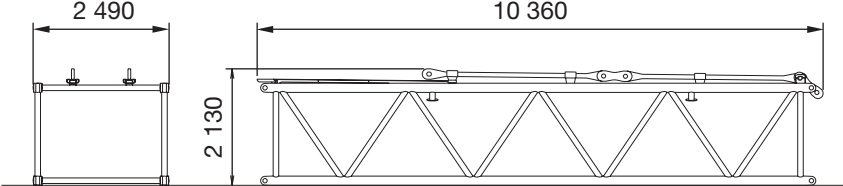
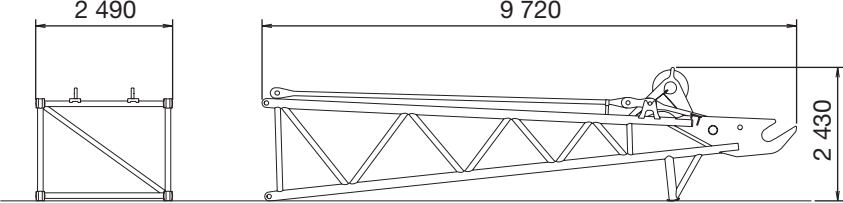
Description	Q'ty	Dimensions (mm)	Mass (kg)
<p>MB 10 Long Mast Base</p>	<p>1</p>	 <p>10 350</p> <p>2 895</p> <p>2 450</p>	<p>16 400</p>
<p>MB 10 Long Mast Extension</p>	<p>1</p>	 <p>2 490</p> <p>10 360</p> <p>2 130</p>	<p>3 900</p>
<p>MT 9 Long Mast Top</p>	<p>1</p>	 <p>2 490</p> <p>9 720</p> <p>2 430</p>	<p>4 600</p>

- We are constantly improving our products and therefore reserve the right to change designs and specifications without notice.
- Units in this specification are shown under International System of Units; the figures in parenthesis are under Gravitational System of Units as old one.

---

## Sumitomo Heavy Industries Construction Cranes Co., Ltd.

9-3, Higashi-Ueno 6-chome, Taito-ku, Tokyo 110-0015, Japan  
Phone: 81-3-3845-1387 Facsimile: 81-3-3845-1394  
<http://www.hsc-cranes.com>