

■ General dimensions

Units: mm

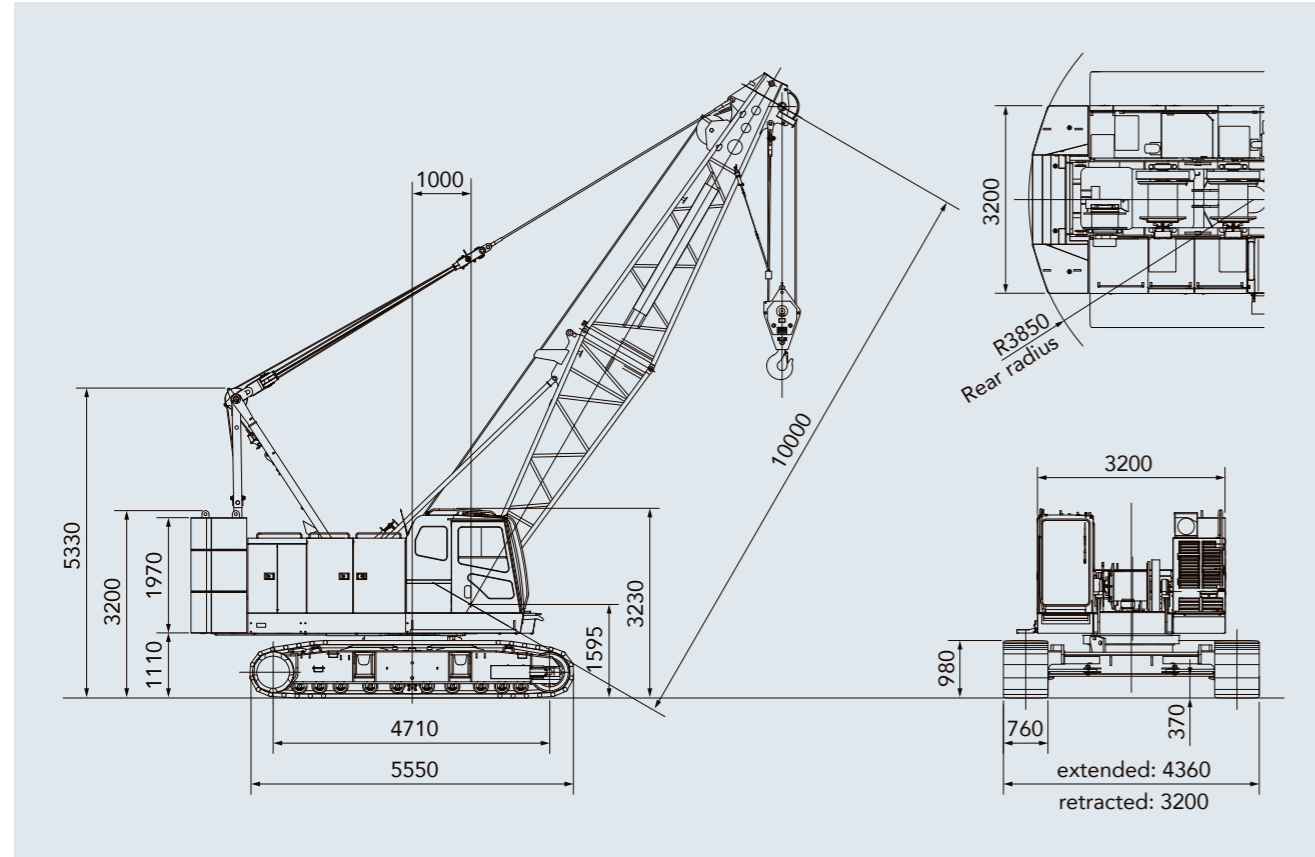

■ Specifications

Model		SCX550-3	
Application		Liftcrane	Clamshell
Max. lifting capacity	t × m	55 × 3.7	—
Basic boom length	m	10.0	10.0
Max. boom length	m	49.0	19.0
Crane jib length	m	6.0~15.0	—
Max. boom + crane jib length	m	43.0 + 15.0	—
Rope line speeds (*1)	Front/rear main drum (rated with 6.5 t load)	m / min	110 (53)
	Boom hoist drum	m / min	60
Swing speed	min ⁻¹ (rpm)	4.2 (4.2)	4.2 (4.2)
Travel speed high/low (*2)	km/h	2.0 / 1.5	2.0 / 1.5
Gradeability	% (°)	40 (22)	40 (22)
Bucket capacity	m ³	—	0.8/1.0/1.2
Allowable gross weight	t	—	6.0
Max. digging depth	m	—	36
Engine	Make & model	Hino J05E-UN (Stage IV)	
	Max output	kW/min ⁻¹ (PS/rpm)	138/2100 (188/2100)
Ground contact pressure	kPa (kgf/cm ²)	73.1 (0.75) w/basic boom, 55 t hook block	75.1 (0.77) w/basic boom, 1.2 m ³ bucket
Operating weight	t	Approx. 53.4 w/basic boom, 55 t hook block	Approx. 54.8 w/basic boom, 1.2 m ³ bucket

Notes: 1. Rope line speeds vary under load and operating conditions (*1). 2. Travel speed is based on flat, level and firm supporting surface with no load and 10.0 m basic boom (*2).

- We are constantly improving our products and therefore reserve the right to change designs and specifications without notice.
- Units in this catalog are shown under International System of Units (SI). The figures in parenthesis are under the older British Gravitational System of Units.
- Illustrations may include optional equipment and accessories, and may not include all standard equipment.
- Standard equipment and accessories may vary by country and region.

Sumitomo Heavy Industries Construction Cranes Co., Ltd. has been abbreviated as "HSC" throughout this catalog. "HSC CRANES" is a brand of Sumitomo Heavy Industries Construction Cranes Co., Ltd.

Address inquiries to :

Sumitomo Heavy Industries Construction Cranes Co., Ltd.
 9-3, Higashi-Ueno 6-chome, Taito-ku, Tokyo 110-0015, Japan
 Phone: 81-3-3845-1387 Facsimile: 81-3-3845-1394
<http://www.hsc-cranes.com>

Printed in Japan
 1910 ©05H.EA334

**SCX
 550-3**



Evolution that makes a difference.

The 55 t class crawler crane offers excellent operating versatility across a broad range of work sites.

The SCX550-3 delivers ample performance in a compact body, and has been fine-tuned for the needs of today as well as tomorrow, with superior operability, safety, transportability, eco-friendly design and so much more.

With refined usability, efficient operations and low fuel consumption, the innovative SCX550-3 makes a clear difference the more it is used.

Find out exactly how it can transform your worksite and lead your business to even greater heights.



SCX 550-3





SCX550-3 PERFORMANCE & CONTROL

Compact size and high performance for any site.

Cranes for building the society of tomorrow require the operating capability to suit a broad range of worksites. The SCX550-3 has superior performance capable of lifting loads up to 55 t, as well as outstanding mobility on the ground. Proven reliability and advanced efficiency mean the SCX550-3 is designed for working on tough sites.

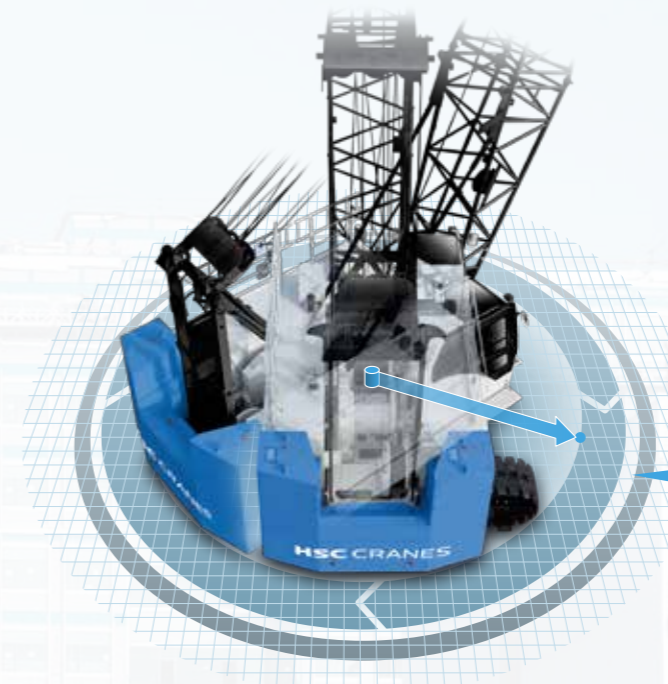

Compact body ideal for any site conditions

The counter weight width has been kept to 3200 mm, and a rear swing radius of 3850 mm ensures safe operations on sites with limited space. The SCX550-3 caters to work required for any business as it is designed to meet a greater range of site conditions.

SCX550-3
Rear radius **3850mm**

Lifts up to 55 t loads with the smallest rear radius in its class*.

SCX550-3
Counter weight width **3200mm**

It's the ideal size for so many work sites!
*50 t class crawler cranes

Winch with installed reduction gear

The front and rear winch feature the same design as previous models with its simple structure and installed reduction gear (with feel-fall function). Core crane functions can be controlled using only the hoisting lever, making operations so user-friendly and efficient. The same hand brake function as previous models has also been retained. The superior pedal and hoisting lever control system make clamshell and other bucket operations smoother, while braking pressure can be adjusted for various types of excavation work.



Minimal fuel consumption and high-speed winching with light loads

Simple operation ECO winch mode is activated automatically using the ordinary control levers if the ECO winch switch is ON and certain operating conditions are met (hook only, 1350 rpm or lower engine speed).

Eco winch mode with high-speed winching and low-fuel consumption

Also included is a new Eco winch mode, which allows high line speeds under light loads without having to increase the engine speed (low rpm). This mode delivers outstanding workability in situations such as high-elevation construction sites and multiple rope hanging operations and also limits fuel consumption and noise as engine speed can be kept at a minimum.

Better swing feel

The electrohydraulic system has been redesigned to increase the swing speed as well as make swinging smoother for a greater level of control. A swing neutral free/brake mode selector (cannot be installed later)* as well as a swing brake operation pedal* are also available for a level of control exactly as intended by the operator.



* Optional

Swing mode selector switch

Slow speed control for single boom hoisting

Independent fine-speed control of the boom is provided for greater precision of the work radius. Stepless adjustment is available from low to high speeds.



SCX550-3 UTILITY

Excellence with any operation. Superior mobility and versatility.

A high level of power and mobility all in a compact body means the SCX550-3 delivers excellent results anywhere, from ordinary crane operations to foundation work and excavation.

Reduction counter weight specification (optional) and other configurations are available to help streamline transportation and assembly, which further increases efficiency and versatility on work sites.

Capable on any type of site, any type of work

Crane operations

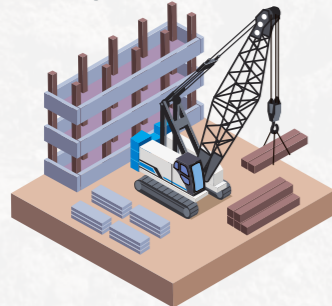

Ample lifting capable for up to 55 t loads means quick and smooth operations, from the delicate control required for hoisting loads off the ground, to high-precision inching work.

Foundation work

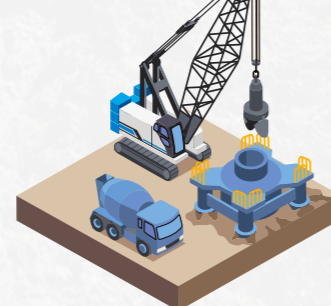

High-load foundation work can be completed easily with the superior control and high rigidity body of the SCX550-3. Wide winch drums mean adds stability to operations.

Clamshell excavation

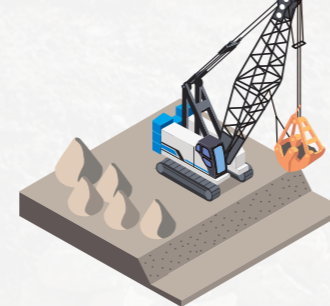



The superior pedal and hoisting lever control system make bucket work like clamshell and drag line operations smooth and stress-free.

Transportation width kept to 3.2 m

The crawler retractors mean the width of the crane during transportation can be kept to 3.2 m (100 mm less than the previous model). This design also ensures greater transportation options are available using 3.2 m-wide trailers. Retractor lock pins can be accessed from outer side of the crane body for greater work safety.

Multi-use reduction counter weight specification OPTION

Reduction counter weight specification is available as an optional extra (with counter weight detector) to provide added flexibility for a diverse range of worksites such as on platforms or bridges with weight restrictions. The SCX550-3 can work on even more work sites with counter weights reduced.

Counter weight			
	Std	-1 layer	-2 layers
Total operating weight	53.4 t	49.9 t	43.5 t
Ground contact pressure	73.1 kPa	68.3 kPa	59.5 kPa

Note: Reduction counter weight specifications are configured to suit crane specifications excluding the crane jib.

Newly designed shoe tension unit

An oil pump type shoe tension unit has been used for the first time to make injecting oil easier, which enhances maintenance work compared to the previous grease pump type.

Counter weight & boom hanging lugs

A horizontal type counter weight for piling weights flatly has been newly used, together with hanging lugs mounted on the boom top, boom and boom insert to help streamline the assembly process. A boom connection pin holder has been installed for the boom top, boom and boom insert, and a bridge storage clip installed on the gantry.



Boom hanging lugs



Connection pin holder

Reliable and precise. Advanced safety features for the unexpected.

The highest level of safety is the utmost priority. A simple and concise user interface ensures that information is provided to the operator as reliably as possible. The SCX550-3 is equipped with a host of warnings and redundant safety devices to ensure protection when it is needed. Enhanced safety systems provide greater reassurance and peace of mind during work.

Moment limiter display

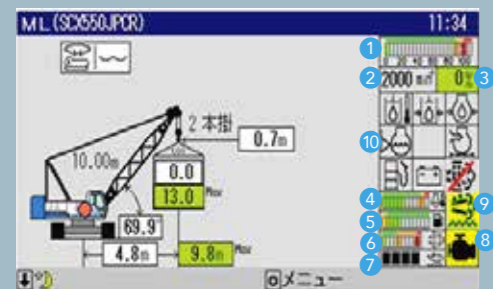

- | | |
|--------------------------------------|---------------------------------|
| 1 Load ratio indicator (%) | 6 Soot level gauge |
| 2 Engine speed | 7 Urea fluid gauge |
| 3 Load ratio (%) | 8 Engine trouble alarm (yellow) |
| 4 Water temperature (engine coolant) | 9 Urea SCR system display |
| 5 Fuel gauge | 10 Warning icons |

Moment limiter with large screen display

A large screen display has been used offering excellent visibility and field of view of any job. A host of items can be shown, while a simple display layout ensures that information is provided to the operator properly. The display has also been designed with an interactive interface to follow any movement of the crane from a safety perspective, which helps to limit unintended operations and maintain utmost safety.

ML Anti-two block

A new anti-two block using a lifting height indication device is offered as a standard equipment. When a height restriction is set in advance in the lifting height meter, the slowdown function will kick in as the restricted height is approached to prevent hook overhoist. Together with the anti-two block switch, the lifting height moment limiter provides a redundant level of safety against hook overhoist, leading to improved safety.

Note) This function plays a supplementary role to the existing moment limiter and use of this equipment alone is prohibited by laws and regulations.

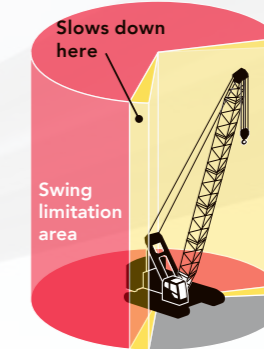
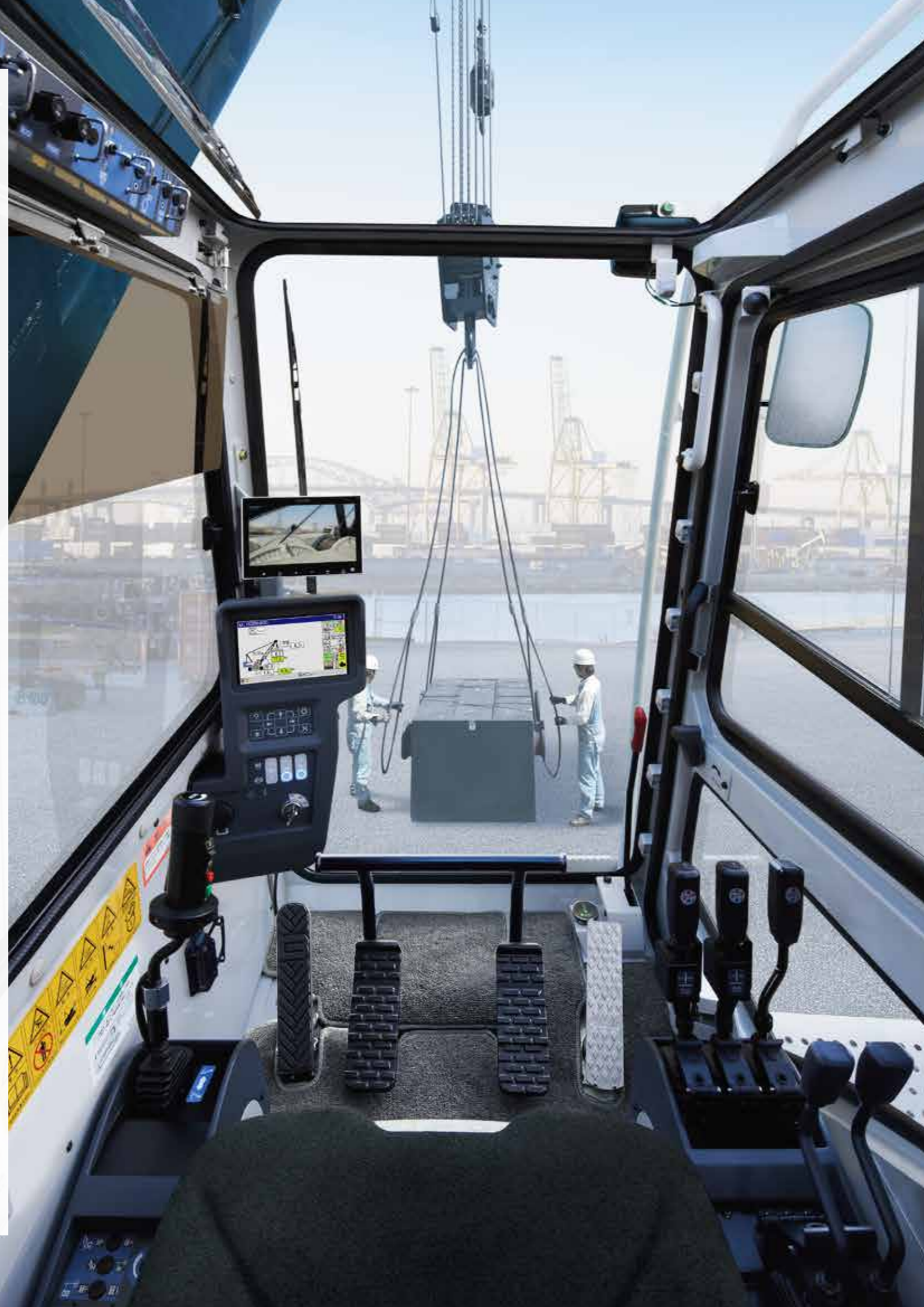

Swing restriction unit* OPTION

The swing restriction unit prevents the crane from swinging into objects by allowing the swing range to be preset, and notifying the operator of the swing range and automatically stopping the crane when required. Together with the restricted swing range function, the result is an added level of safety when working in tight areas.

* Available as an option in a combination with the swing neutral free/brake mode selector switch (cannot be installed later).

Drum and rear monitoring camera OPTION

An optional drum and rear monitoring camera is useful for keeping an eye on winch conditions. The switchable camera view makes it easy to monitor the movement of each section (6 areas) of the crane. The camera also has a magnetic mount so that it can be relocated for better visuals to suit any working environment.



Rear view monitor camera

Designed for safe operation

The auto drum lock function is equipped as standard, to automatically apply the drum lock to the hoisting winch when the hoisting lever is in the neutral position. Various warnings and alerts provide warning alarm buzzers to the operator and others nearby to minimize accidents caused by carelessness. Hand rails (folding) are also included as standard for greater safety during maintenance.

Other safety functions and devices

- Three color percentage indicator
- Anti-two block
- Gate lock lever
- Engine emergency stop switch
- Winch drum lock (front/rear)
- Independent winch operation lever locks

Supreme visibility and functionality for greater comfort, greater safety.

Designed to make the stressful job of operators, more stress-free and more comfortable. Excellent visibility is just the start, and with easy-to-use accessories and an ergonomic control layout, the SCX550-3 is designed to make things smooth. These all help to reduce operator fatigue, while at the same time increasing comfort and functionality for maximum performance, day-in, day-out.



Better visibility in all directions

The cab has extra-wide windows to improve visibility in all directions. Green tinted safety glass has been used all round to protect the operator from UV rays and objects that may have come free during operation. The wipers now sweep a greater area to make work easier, even when working in rain.



Highly-functional seat for optimum work position

The new seats are designed with the ideal shape for a more comfortable seating position. The wide range of seat adjustments means it suits any body shape, for the best work and a relaxing posture. A seat with suspension is available as an optional extra.

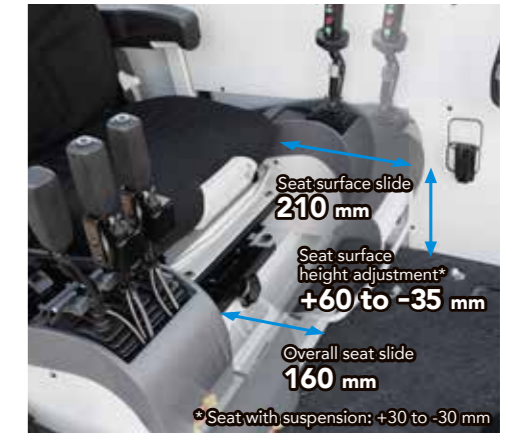

Wide range of seat adjustments



Full-flat design for resting

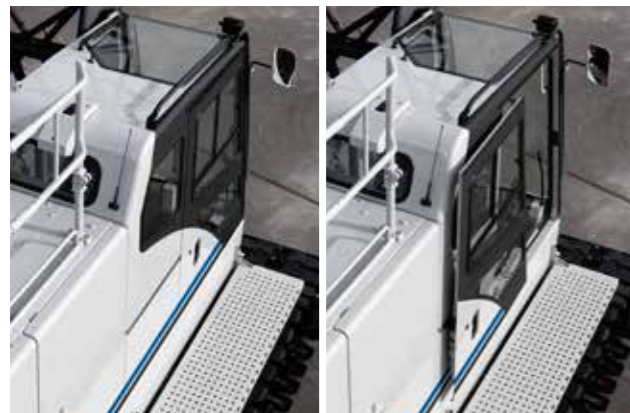

New large sliding door

A sliding door and wide platform have been implemented to reduce the amount of space required when opening and closing the door, which makes getting in and out of the cab a breeze. Access steps are also installed on the crawler side frame.

Various items for more comfortable work



Cross operation lever **OPTION**



Wipers with greater sweep area



Sunshade



Cab roof window guard **OPTION**
The photo is a different color to the standard color (black).



Control levers with drum rotation sensor

Control levers are designed for better operation with optimization made to the pitch, and a winch drum rotation sensor is also included. Any rotation in the winch is conveyed to the operator via the levers, for full control required for precision hoisting jobs. The result is smooth winching where accuracy is vital, such as positioning bolts with the crane.



Upper cabin controller

Controllers for the wipers, work lights, drum lock and other functions have been installed higher up near frequently used controls for a more natural layout.

Useful and functional interior accessories



Outside-air intake air-conditioner



Cup holder



AM/FM radio (with clock)



Storage shelf

**The highest level of clean performance.
Environmentally-friendly design to redefine mankind and society.**

It is fitting that the most advanced technology is installed in a machine designed to redefine the future of society. The SCX550-3 brings together a new cleaner running engine and advanced control system (ECO winch mode, auto idle stop function) for energy-efficient operation. Compliant with EU Stage IV exhaust gas emission regulations, the SCX550-3 also offers exceptional fuel efficiency and outstanding operation and control.

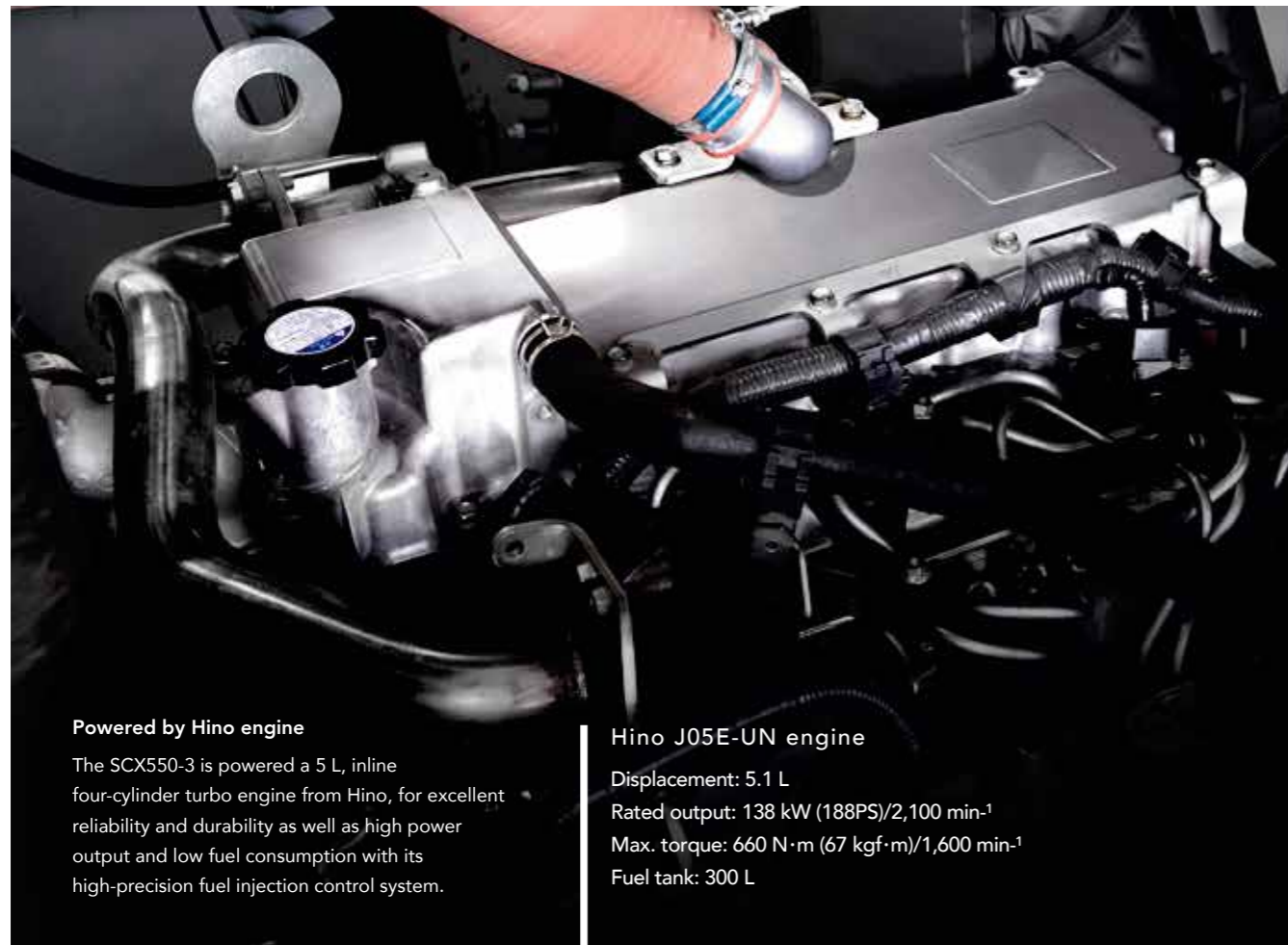

Powered by Hino engine

The SCX550-3 is powered a 5 L, inline four-cylinder turbo engine from Hino, for excellent reliability and durability as well as high power output and low fuel consumption with its high-precision fuel injection control system.

Hino J05E-UN engine

Displacement: 5.1 L
Rated output: 138 kW (188PS)/2,100 min⁻¹
Max. torque: 660 N·m (67 kgf·m)/1,600 min⁻¹
Fuel tank: 300 L



New clean engine

The new clean engine featuring the advanced eco technology "Urea SCR System" compliant with EU Stage IV exhaust gas emission regulations. Compared to the previous model (Stage III A), emissions of NOx (nitrogen oxides) and PM (particulate matter) have both been reduced by approximately 90%. In addition to the lowest level of exhaust gas emissions, lower fuel consumption also helps to cut down on CO2 emissions. The SCX550-3 represents the path of evolution into a more eco-friendly machine.

Clean performance (JPN)

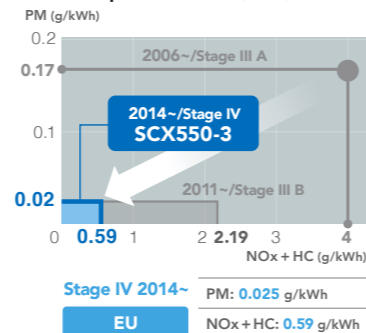

Urea tank



DPR + Urea SCR

DPR + Urea SCR system

A DPR (muffler filter) and Urea SCR system are installed as the exhaust gas aftertreatment device. The initial muffler filter reduces PM emissions, while the secondary Urea SCR system reduces NOx emissions. The Urea SCR system injects AdBlue® (urea fluid) into the exhaust gas to break down NOx gases into harmless water and nitrogen via a chemical reaction. Treating the NOx in the exhaust helps to maintain the engine's high combustion efficiency, which increases its fuel efficiency and power output.

AdBlue® is a registered trademark of the German Association of the Automotive Industry.

Precautions with the new clean engine

- Always use diesel for the fuel, specified lower ash oil (DH-2 <JASO>, CJ-4 <API> class) for the engine oil, and specified engine coolant. The DPR + Urea SCR System may undergo automatic regeneration (cleaning) to maintain its performance level.

Other fuel efficiency technology



Auto idle stop function
Minimizes excess fuel consumption during work



ECO winch mode (see page 5 for details)
Reducing wastage during light load work, increasing productivity

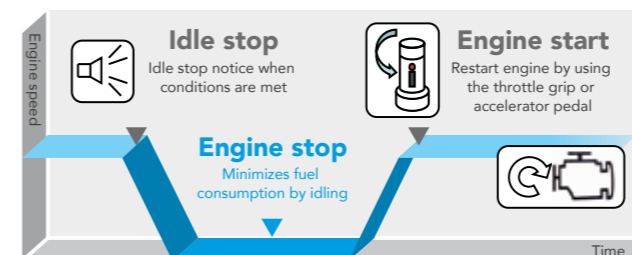

A new auto idle stop function is available for energy-efficient operation and minimal exhaust gas emissions. This prevents unnecessary idling during work to help reduce fuel consumption and limit the level of wear throughout various components. There is no impact on work, as the function stops the engine if the switch is ON and the required conditions are met, and restarts the engine when the accelerator is used.



Fuel economy has been improved drastically when winching up and down with light loads. This design ensures energy-efficient operation over repetitive movements or working with loads at heights.

Exceptional peace of mind and convenience for worksites.

REMOTE SENSING

"REMOTE SENSING" system installed as standard

Precise monitoring of the crane's operating condition to minimize downtime and ensure accurate maintenance. Keeping machines in the best possible operating condition helps to improve operating efficiency, while also reducing the time and cost required for maintenance.

Store data on machine conditions and operations, remote management

(total operating time management, position information with GPS, operating condition management such as work conditions)

Minimize downtime

Accurate maintenance

Better safety

Image of REMOTE SENSING

Precise machine information contributes to efficient operation

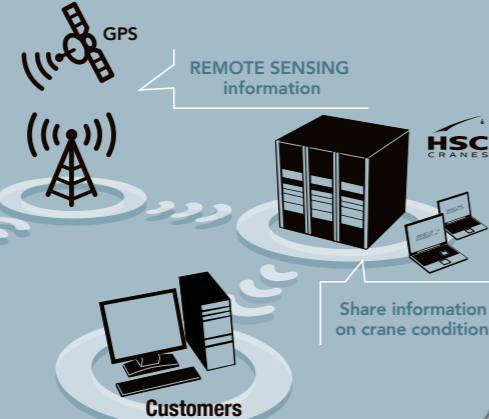

*Photos may differ to the specifications of available products.

Advanced eco-friendly "Urea SCR System" technology

The SCX550-3 meets the latest emissions regulations, and uses a DPR (muffler filter) and the advanced eco-friendly "Urea SCR System" technology. The Urea SCR System achieves both lower exhaust gas emissions and lower fuel consumption. The reduction in fuel use helps to prevent global warming (reduced CO₂ emissions).

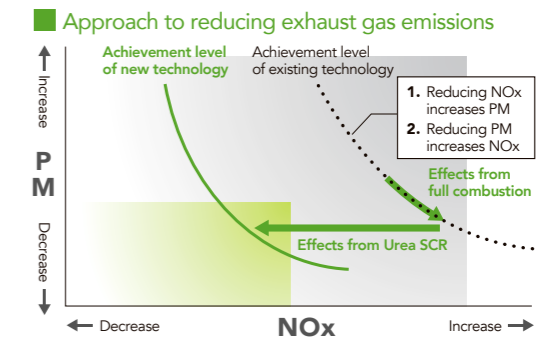

Urea SCR System design

- 1 Reduces fuel consumption and limits PM generation with high-efficiency engine combustion
- 2 Oxidizes HC (hydrocarbons) and CO (carbon monoxide) from the engine with an oxidation catalyst
- 3 Injects AdBlue® into the exhaust gas. Breaks down NOx to harmless water and nitrogen

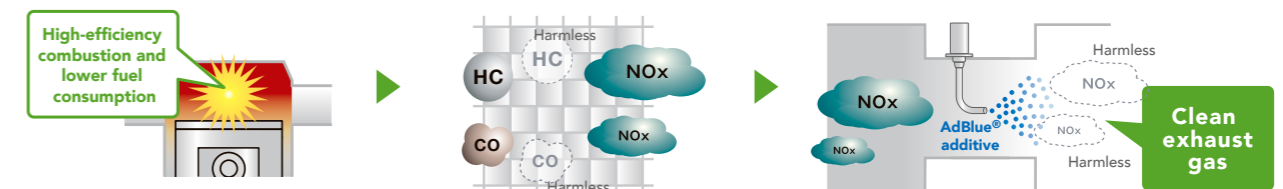

This image is to highlight the effects of the system, and has been exaggerated for illustration purposes.

What is AdBlue®?

The trademark of a high-quality urea aqueous solution standardized in Europe for using the Urea SCR System.

Refilling frequency
Once per two refuelings

The SCX550-3 requires AdBlue® to be refilled once every two times the machine is refueled. (AdBlue® consumption may vary slightly depending on operating conditions)



Precautions with machines installed with the Urea SCR System

To ensure that the machine can be used safely and smoothly, use AdBlue® aqueous solution (or a urea aqueous solution that complies with JIS or ISO standards). Using a non-standard aqueous solution or diluting the solution before use may cause mechanical problems. Malfunctions arising from the use of non-standard aqueous solutions are not covered by the HSC warranty service.

- The remaining AdBlue® level can be checked during work on the monitor display (Moment Limiter) in the cab. A warning is displayed on the monitor when the remaining level becomes low or there is an issue with quality.
- The engine power output will be limited if the remaining AdBlue® level falls below the minimum level or there is an issue with quality, so be sure to plan refills in advance.
- The Urea SCR System is designed exclusively for the machine, and must not be used for any other purpose.
- Rinse with water any solution that comes in contact with skin.
- When storing the solution, always use sealed containers and store at room temperature in a well-ventilated location out of direct sunlight. When carrying the solution, always use the container that the solution was purchased in, or other specified container.
- The Urea SCR System includes a heater function, however sufficient care must be taken to prevent freezing when the solution is stored in cold regions (freezing temperature: -11°C)
- Read the instruction manual for more details.

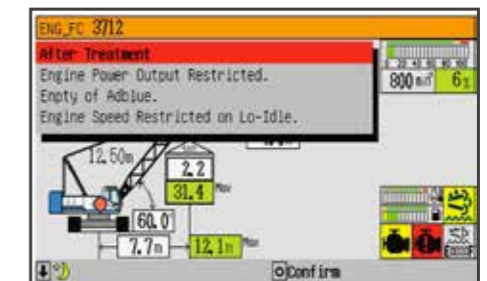

Example monitor warning display