

SCX1800A-3

Stage III A / Tier 3

Stage V

SCX 1800A-3

HYDRAULIC CRAWLER CRANE

Hoist Rope 28mm



Variation of The Attachment

Line Speed *	Front / Rear Winch	m/min	110 (45)
	Boom Hoist Winch		44
Swing Speed	min ⁻¹ (rpm)		1.8
Travel Speed High / Low *	km/h		1.1 / 0.6
Gradeability	% (Degree)		30 (17)
Engine Model		Cummins QSB6.7 (Stage IIIA / Tier 3) Cummins B6.7 (Stage V)	
Engine Rated Output Power	kW/min ⁻¹ (ps/rpm)	Stage IIIA / Tier 3	201 / 2000 (273 / 2000)
		Stage V	209 / 2000 (284 / 2000)

Note : Speeds marked with "*" may vary depending on load applied.

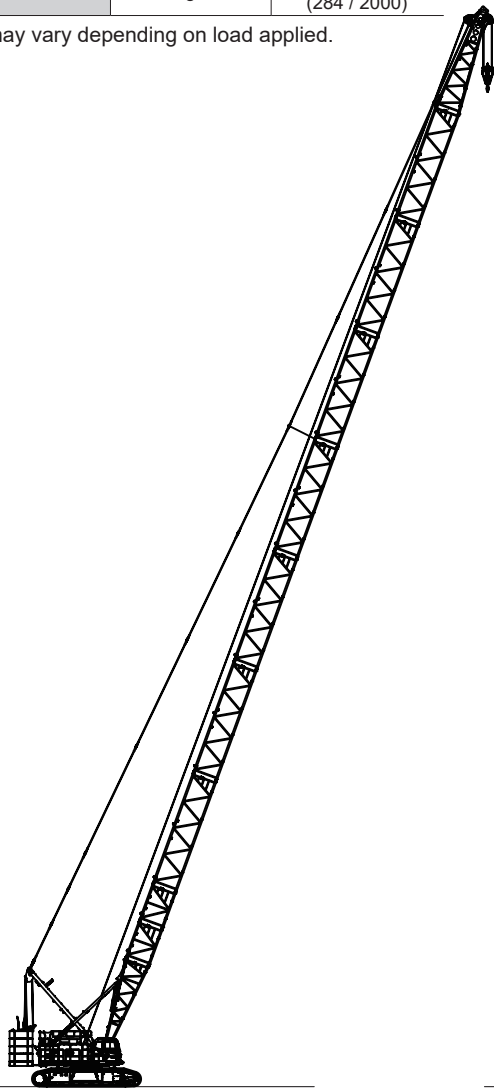

**Crane Specification
(Boom Longest Length)**

Boom Length (Without Skywalk)	m	15 to 84
Ground Contact Pressure (Without Skywalk)	kPa (kgf/cm ²)	108 (1.10) (Boom longest length with 35 t hook)
Overall Operating Weight (Without Skywalk)	t	Approximately 176 (Boom longest length with 35 t hook)
Boom Length (With Skywalk)	m	15 to 81
Ground Contact Pressure (With Skywalk)	kPa (kgf/cm ²)	108 (1.10) (Boom longest length with 35 t hook)
Overall Operating Weight (With Skywalk)	t	Approximately 177 (Boom longest length with 35 t hook)

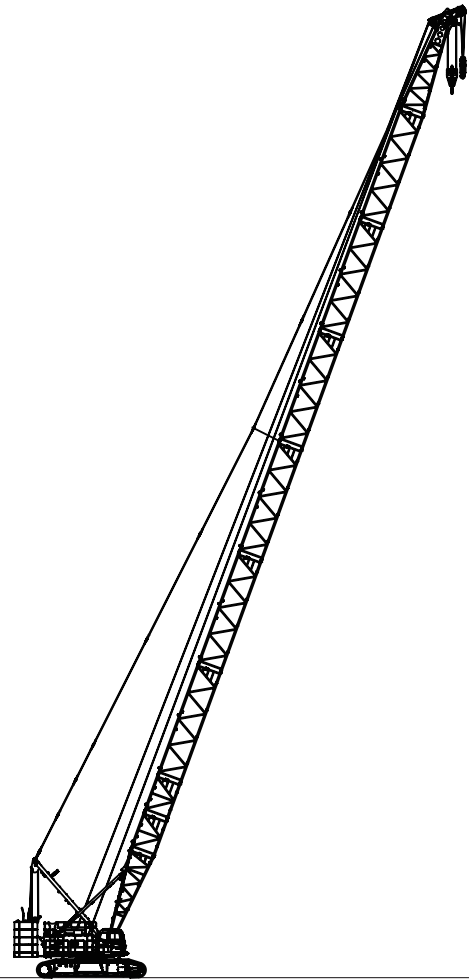

**Crane Specification
(Boom Longest Length with Aux. Sheave)**

Boom Length (With/Without Skywalk)	m	21 to 78
Ground Contact Pressure (With/Without Skywalk)	kPa (kgf/cm ²)	109 (1.11) (Boom longest length + aux. sheave + 80 t + 35 t hook attached)
Overall Operating Weight (With/Without Skywalk)	t	Approximately 178 (Boom longest length + aux. sheave + 80 t + 35 t hook attached)

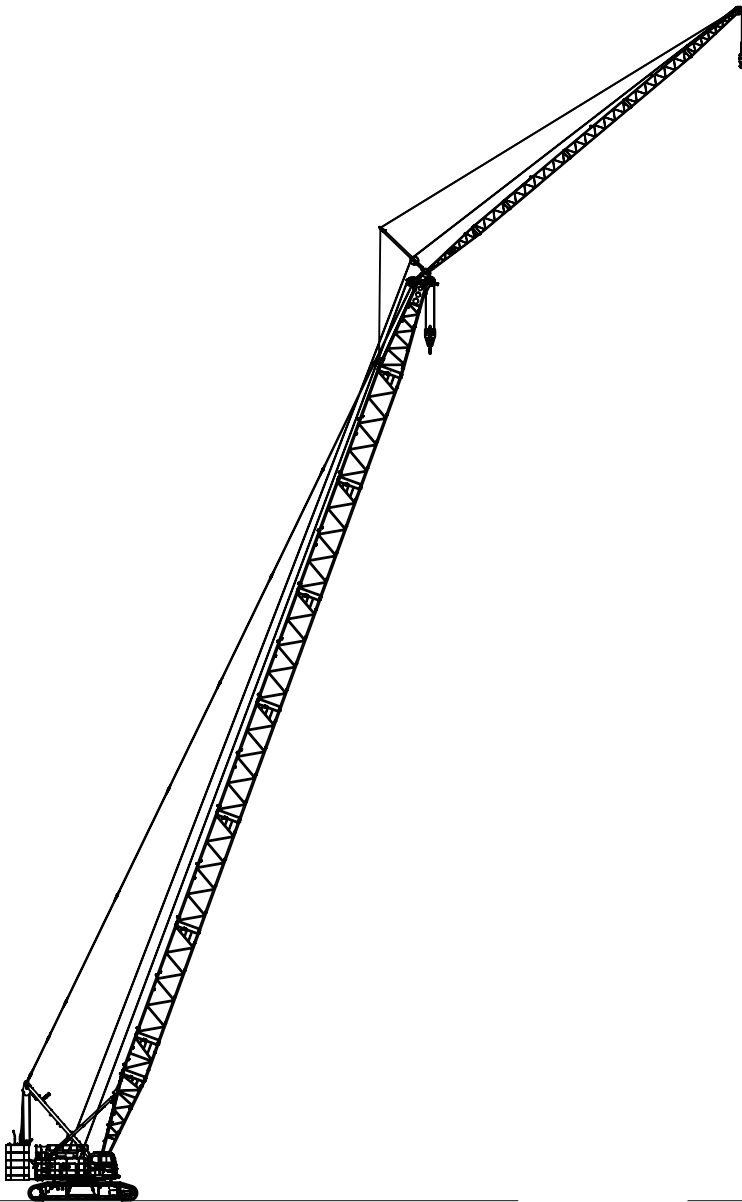

**Crane Specification
(Boom Longest Length with Crane Jib)**

Boom Length (With/Without Skywalk)	m	24 to 72
Crane Jib Length (With/Without Skywalk)	m	13 to 31
Boom + Crane Jib Longest Length (With/Without Skywalk)	m	72 + 31
Ground Contact Pressure (With/Without Skywalk)	kPa (kgf/cm ²)	109 (1.11) (Boom + crane jib longest length 35 t + 13.5 t hook attached)
Overall Operating Weight (With/Without Skywalk)	t	Approximately 178 (Boom + crane jib longest length 35 t + 13.5 t hook attached)

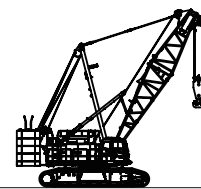

**Crane Specification
(HD Boom Length)**

Boom Length (Without Skywalk)	m	12
Ground Contact Pressure (Without Skywalk)	kPa (kgf/cm ²)	103 (1.05) (12 m HD Boom longest length with 175 t hook)
Overall Operating Weight (Without Skywalk)	t	Approximately 169 (12 m HD Boom longest length with 175 t hook)

VARIATION

Variation of The Attachment	2
------------------------------------	----------

SPECIFICATIONS

Specifications	5
-----------------------	----------

Crane Specifications	6
-----------------------------	----------

Dimensions and Specifications	6
--	----------

Boom and Crane Jib Configurations	7
--	----------

Combination of Boom and Crane Jib (Offset Angle 10° and 30°)	9
---	----------

Working Ranges	10
-----------------------------	-----------

■ Main Boom	10
-------------------	----

■ Aux. Sheave (1 Sheave).....	11
-------------------------------	----

■ Aux. Sheave (2 Sheaves).....	12
--------------------------------	----

■ Crane Jib	13
-------------------	----

Gross Rated Load Table	14
-------------------------------------	-----------

■ HD Boom	14
-----------------	----

■ Main Boom	14
-------------------	----

■ Aux. Sheave (1 Sheave).....	16
-------------------------------	----

■ Aux. Sheave (2 Sheaves).....	18
--------------------------------	----

■ Main Boom with Aux. Sheave.....	20
-----------------------------------	----

■ Main Boom with Aux. Sheave (2 Sheaves).....	22
---	----

■ Crane Jib	24
-------------------	----

■ Main Boom with Crane Jib	37
----------------------------------	----

TECHNICAL DATA

Weights and Dimensions of Disassembled Units	45
---	-----------

Weights and Dimensions List	45
-----------------------------------	----

Equipment List	50
-----------------------	-----------

Standard and Optional Equipment	50
---------------------------------------	----

Specifications



Engine

Model	Cummins QSB6.7 (Stage IIIA / Tier 3) / Cummins B6.7 (Stage V)	
Type	4-cycle, Water-cooled, Direct injection, Turbo-charged, Diesel engine	
Displacement	6.7 liters	
Rated Output	Stage IIIA / Tier 3	201 kW / 2,000 min ⁻¹ (273 ps / 2,000 rpm)
	Stage V	209 kW / 2,000 min ⁻¹ (284 ps / 2,000 rpm)
Fuel Tank Capacity	457 liters	
Notes	Engine meets Stage V of engine exhaust gas emission regulations. Also, available is a Tier 3 / Stage III A-compliant engine. Engine rated horsepower is based on international rating formula that includes engine alternator and without fan.	



Control

Control System	Main actuators are actuated by main hydraulic system controlled with pilot hydraulic system. Safety devices are securely operated by combined various electronic control with hydraulic system. Working speed can be precisely controlled according to control lever stroke and control dials depending on work.
Control Levers	Designed and positioned based on ergonomics. Armchair lever type is standard. Cross operation lever type and front lever type are available as option.
Display Panel Design	8 inches size. Located to check work state easily without disturbing the view of the operator.



Hydraulic System

Hydraulic Oil Tank Capacity	320 liters		
Hydraulic Pump Capacity	Max.	31.4 MPa	
	P1	266 liters / min	for Front, Rear, boom hoist winch and travel
	P2	266 liters / min	for Front, Rear and travel
	P3	160 liters / min	for Swing, Jack and Sideframe connect
	P4	41 liters / min	Pilot control, Brake cooling, Reeving, etc.
	P5	41 liters / min	
	P6	41 liters / min	
P7	32 liters / min		



Winch

Front and Rear Winch			
Winch	Front	Rear	
Rope Diameter	28 mm	28 mm	
Rope Length	Standard	290 m	225 m for Aux. sheave
	Winding Capacity	-	225 m for Crane jib
Line Pull	Rated	294 m	294 m
Standard Equipment	Free fall winch with brake controlled by pedal operation. High-speed winching is possible by ECO winch mode with low engine speed under light loads.		
Boom Hoist Winch			
Rope Diameter	22.4 mm		
Rope Length	Incorporated	250 m	
Hydraulic motor with multi-disc brakes.			



Swing System

Consisted of 2 hydraulic motors with reduction gear and multi-disc brakes and a swing bearing which has inner tooth. Optional swing brake pedal enables operator to control swing precisely.



Mast

Mast is box structure. Easy assemble for front attachment.



Counter Weight

Counter Weight	Total Weight	67 t
	Base Weight	12 t × 1 piece
	Counter Weight	6.88 t × 8 pieces
Lower Weight	Total Weight	16 t
	Lower Weight	8 t × 2 pieces



Carbody Frame

Welded steel construction with jack up device and crawler sideframe connect cylinders.



Crawler Sideframe

Frame	Welded steel box construction. Hook on and joint pin design for crawler sideframe connection to carbody frame.	
Shoe	Cast iron 1120 mm width flat shoe each side.	
Upper Roller	7 pieces each side.	
	Double flange type : 5 pieces Single flange type : 2 pieces	
Lower Roller	10 pieces each side.	
	Forging heat treated steel with double flange type. 2 plane bearing with floating seal for lifetime lubrication.	
Travel Device	1 piece each side.	
	Hydraulic travel device (Hydraulic motor and reducer)	
	Travel speed (Gradability : 30%)	High : 1.1 km/h Low : 0.6 km/h

Crane Specifications

Dimensions and Specifications

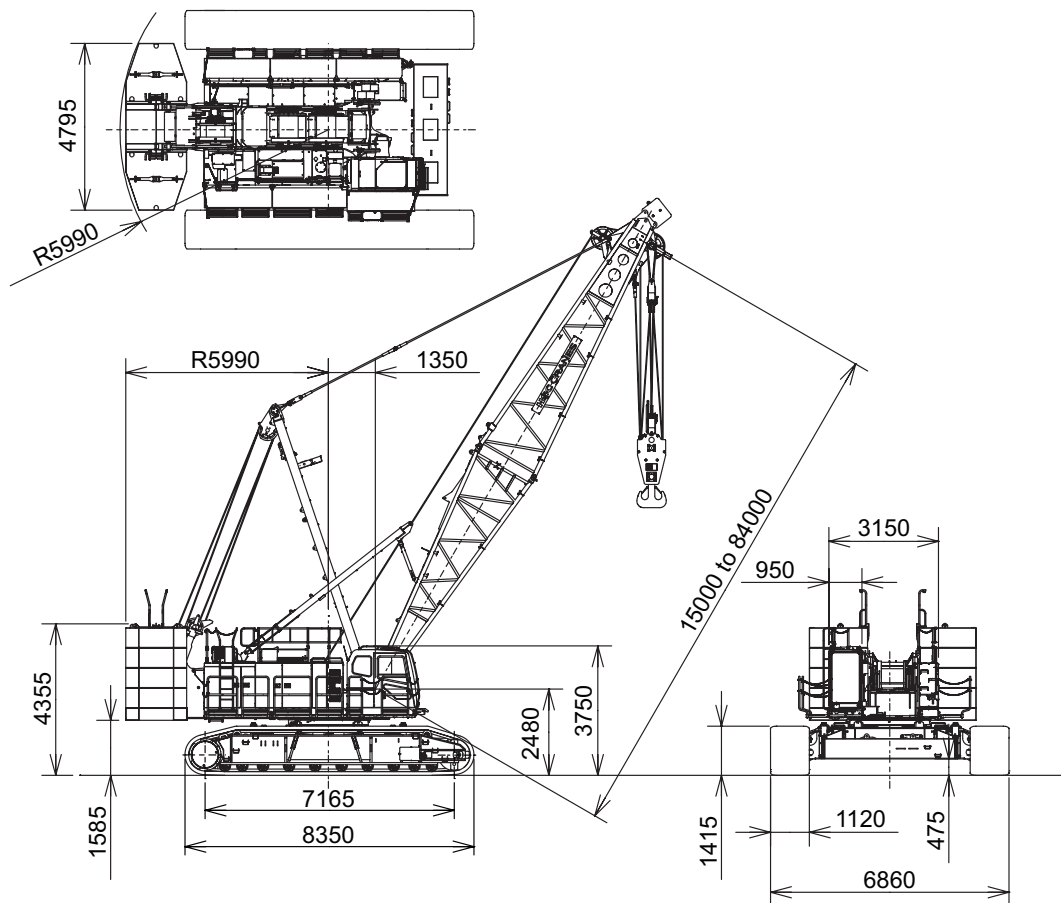

Crane Specifications

Max. Lifting Load × Working Radius (Standard Boom)	t × m	160 × 4.5
Max. Lifting Load × Working Radius (HD Boom)	t × m	175 / 180* × 4.1
HD Boom Length	m	12
Standard Boom Length	m	15
Max. Boom Length	m	84
Crane Jib Length	m	13 to 31
Max. Boom + Jib Length	m	72 + 31
Ground Contact Pressure (Standard Boom)	kPa (kgf/cm ²)	103 (1.05) (w / Standard Boom, 160 t Hook)
Ground Contact Pressure (HD Boom)	kPa (kgf/cm ²)	103 (1.05) (w / HD Boom, 175 t Hook)
Overall Operating Weight (Standard Boom)	t	Approximately 168 (w / Standard Boom, 160 t Hook)
Overall Operating Weight (HD Boom)	t	Approximately 169 (w / HD Boom, 175 t Hook)

Hook Weight

175 t	3,340 kg
160 t	2,590 kg
135 t	2,350 kg
80 t	1,350 kg
35 t	1,070 kg
13.5 t	620 kg

NOTE : Data is expressed in SI units followed by conventional units in ().

* 180 t lifting capacity is limited edition, and requires special equipment.

Boom and Crane Jib Configurations

Boom (1/3)	
Boom Length (m)	Boom Configurations
12	
15	
18	
21	
24	
27	
30	
33	
36	
39	

Boom (2/3)	
Boom Length (m)	Boom Configurations
42	
45	
48	
51	
54	
57	
60	
63	

Aux. Sheave Installable Boom Length																									
Boom Length (m)	12	15	18	21	24	27	30	33	36	39	42	45	48	51	54	57	60	63	66	69	72	75	78	81	84
With Aux. Sheave (1 Fall)	×	×	×	○	○	○	○	○	○	○	○	○	○	○	○	○	○	○	○	○	○	○	○	×	×
With Aux. Sheave (2 Falls)	×	×	×	○	○	○	○	○	○	○	○	○	○	○	○	○	○	○	○	×	×	×	×	×	×

(○: Attachable ×: Not Attachable)

Check the pendant rope with referring to the imprints on the rope end.

Dimensions Not Shown In The Figure		Pendant Rope			
Symbols	Boom Length (m)	Symbols	Length (m)	Rope Diameter (mm)	Imprint
3	3	3	3	40	□ • △ • 40 • 3 • C
4.5	4.5	3.5	3.5	40	□ • △ • 40 • 3.5 • C
6	6	6	6	40	□ • △ • 40 • 6 • C
7.5	7.5	6.9	6.9	40	□ • △ • 40 • 6.9 • C
9	9	9	9	40	□ • △ • 40 • 9 • C

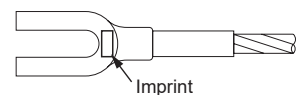

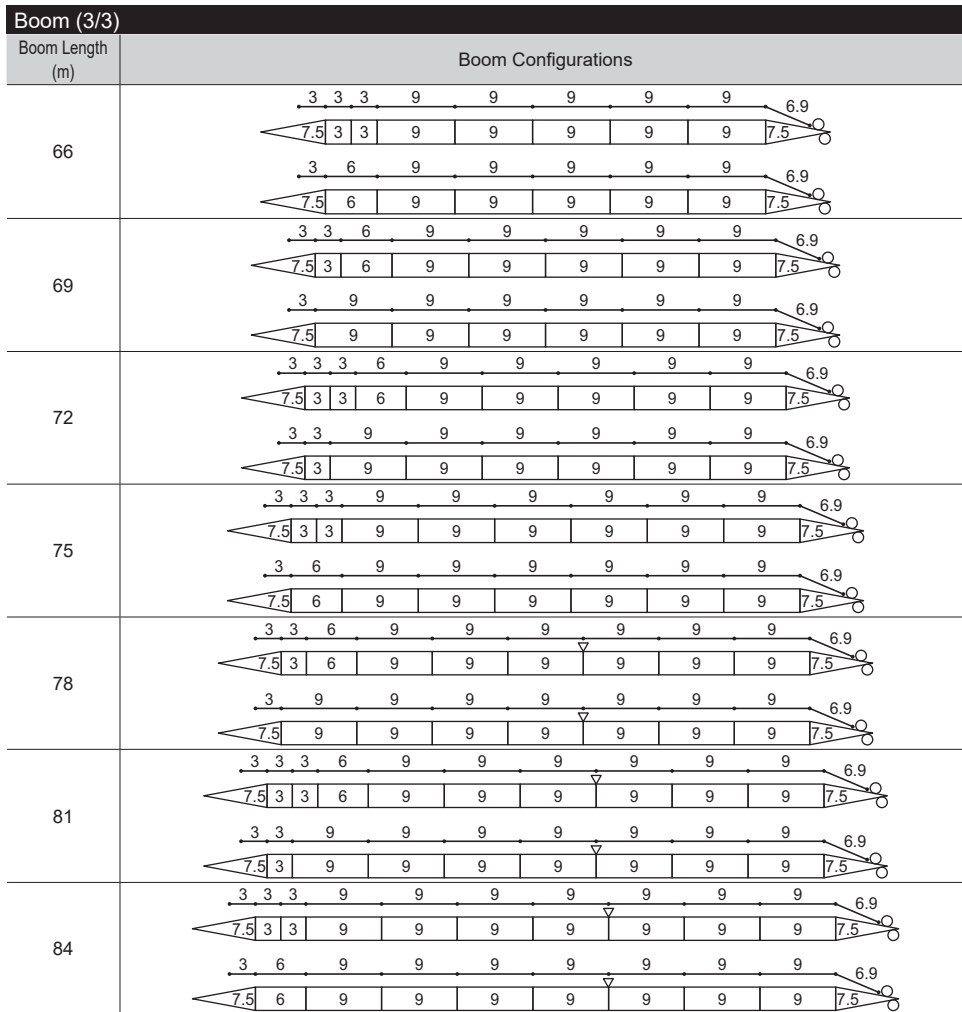

▽ indicates the midpoint pendant rope connection position.

Aux. Sheave Installable Boom Length																									
Boom Length (m)	12	15	18	21	24	27	30	33	36	39	42	45	48	51	54	57	60	63	66	69	72	75	78	81	84
With Aux. Sheave (1 Fall)	×	×	×	○	○	○	○	○	○	○	○	○	○	○	○	○	○	○	○	○	○	○	○	×	×
With Aux. Sheave (2 Falls)	×	×	×	○	○	○	○	○	○	○	○	○	○	○	○	○	○	○	○	×	×	×	×	×	×

(○ : Attachable × : Not Attachable)

Check the pendant rope with referring to the imprints on the rope end.

Dimensions Not Shown In The Figure		Pendant Rope			
Symbols	Boom Length (m)	Symbols	Length (m)	Rope Diameter (mm)	Imprint
3	3	3	3	40	□ · △ · 40 · 3 · C
4.5	4.5	3.5	3.5	40	□ · △ · 40 · 3.5 · C
6	6	6	6	40	□ · △ · 40 · 6 · C
7.5	7.5	6.9	6.9	40	□ · △ · 40 · 6.9 · C
9	9	9	9	40	□ · △ · 40 · 9 · C

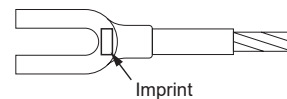

The maximum boom length that can be raised up depends on whether you have a skywalk or not.

	W/o Skywalk	With Skywalk
Main Boom	84 m	81 m
Main Boom with Aux. Sheave (1 Sheave)	78 m	78 m
Main Boom with Aux. Sheave (2 Sheaves)	78 m	78 m

Combination of Boom and Crane Jib (Offset Angle 10° and 30°)

Combination of Boom and Crane Jib (Offset Angle 10° and 30°)																										
Boom Length (m)		12	15	18	21	24	27	30	33	36	39	42	45	48	51	54	57	60	63	66	69	72	75	78	81	84
Jib Length (m)	13	×	×	×	×	○	○	○	○	○	○	○	○	○	○	○	○	○	○	○	○	○	×	×	×	×
	19	×	×	×	×	○	○	○	○	○	○	○	○	○	○	○	○	○	○	○	○	○	×	×	×	×
	25	×	×	×	×	○	○	○	○	○	○	○	○	○	○	○	○	○	○	○	○	○	×	×	×	×
	31	×	×	×	×	○	○	○	○	○	○	○	○	○	○	○	○	○	○	○	○	○	×	×	×	×

(○: Attachable ×: Not Attachable)

Crane Jib (Offset Angle 10° and 30°)		
Crane Jib Length (m)	Offset Angle	Crane Jib Configurations
13	10°	
	30°	
19	10°	
	30°	
25	10°	
	30°	
31	10°	
	30°	

Check the pendant rope with referring to the imprints on the rope end.

Dimensions Not Shown In The Figure	
Symbols	Jib Length (m)
3	3
5	5
6	6

Jib Pendant Rope				
Symbols	Length (m)	Rope Diameter (mm)	Imprint	
1.4	1.4	24	□ • △ • 24 • 1.4 • S	
5.7	5.7	24	□ • △ • 24 • 5.7 • S	
10	10	26	□ • △ • 26 • 10 • S	
12.46	12.46	24	□ • △ • 24 • 12.46	

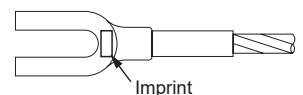

The maximum boom length that can be raised up depends on whether you have a skywalk or not.

	W/o Skywalk	With Skywalk
Main Boom + Crane Jib	72 m + 31 m	72 m + 31 m

Working Ranges

Main Boom

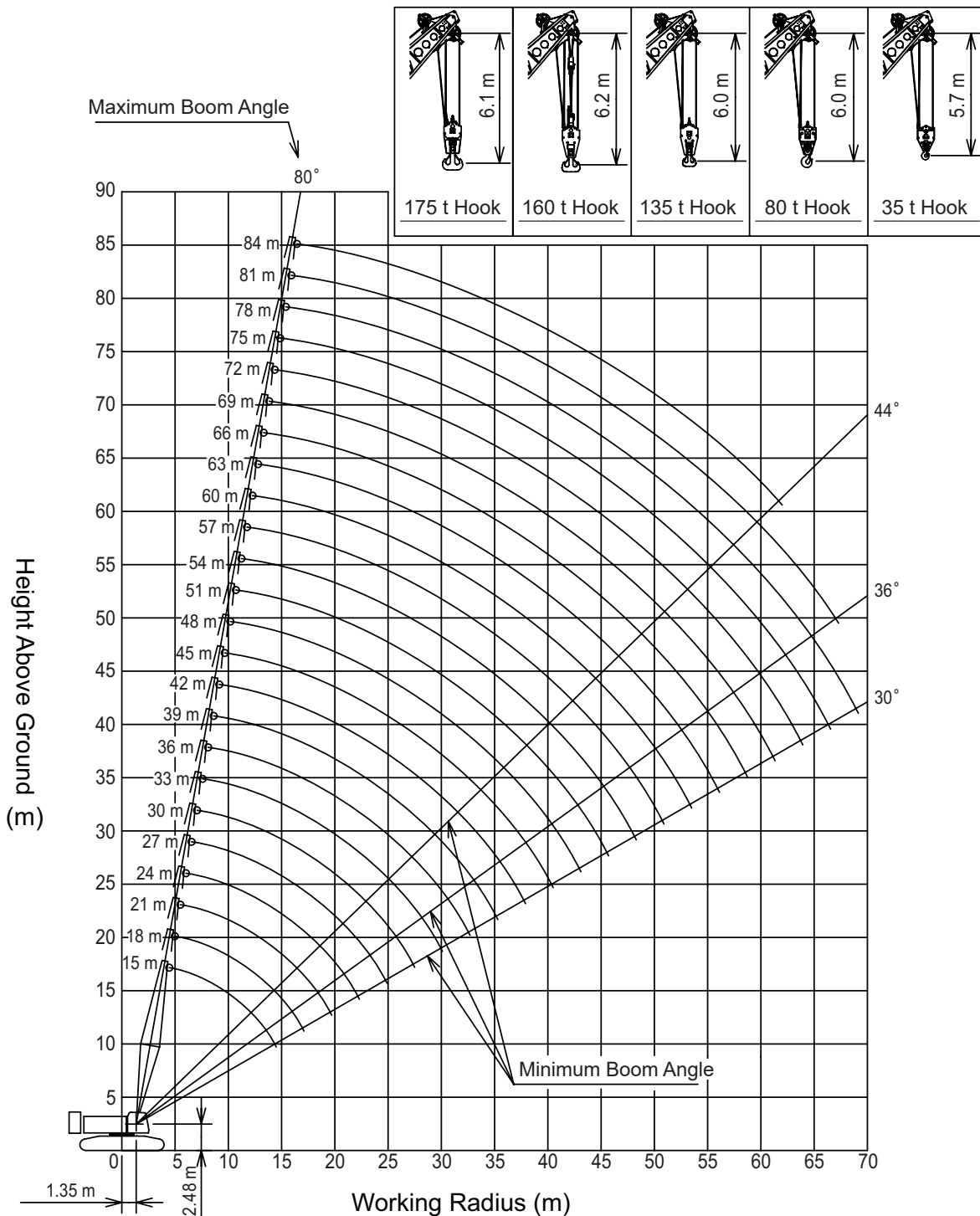

■ Aux. Sheave (1 Sheave)

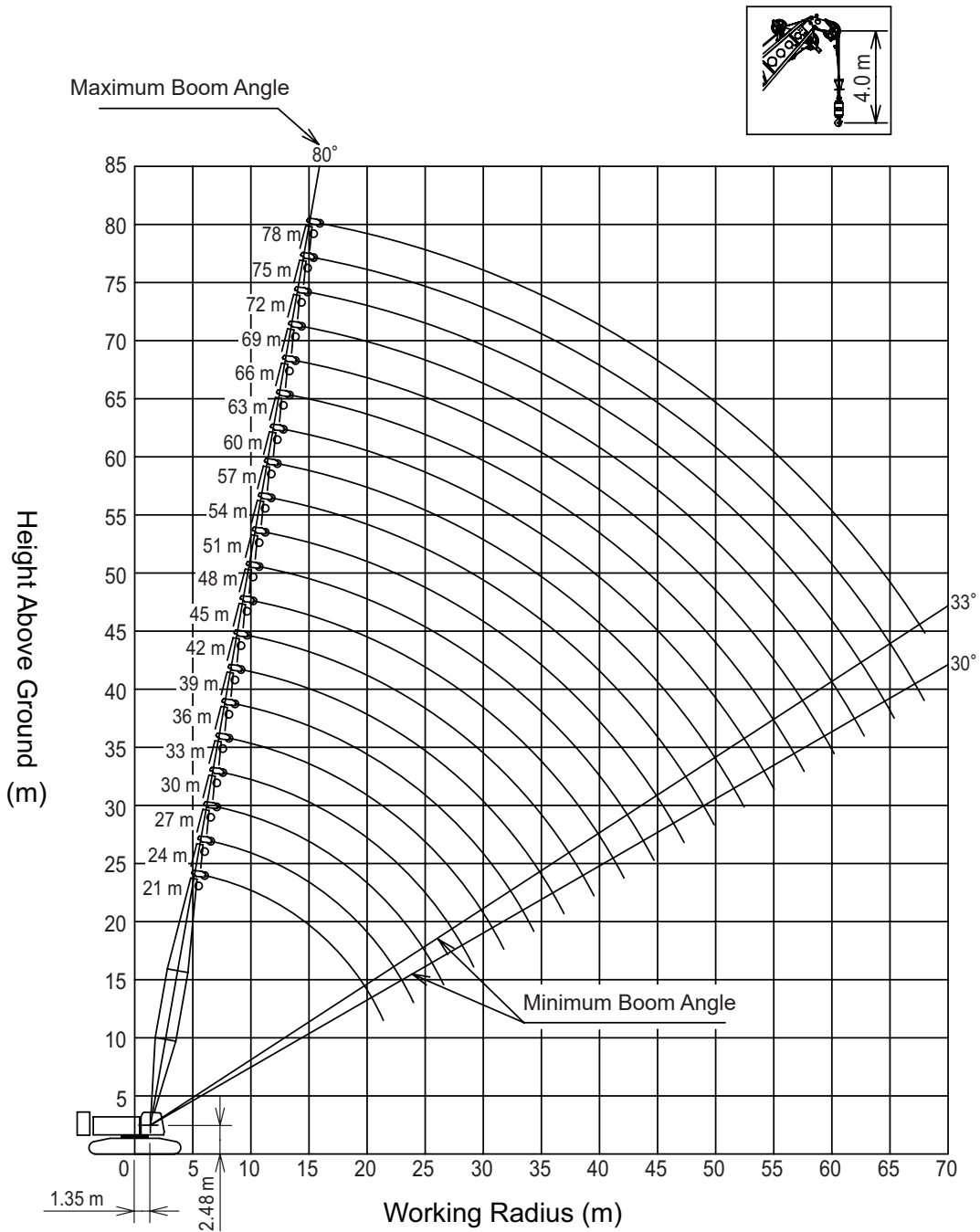

■ Aux. Sheave (2 Sheaves)

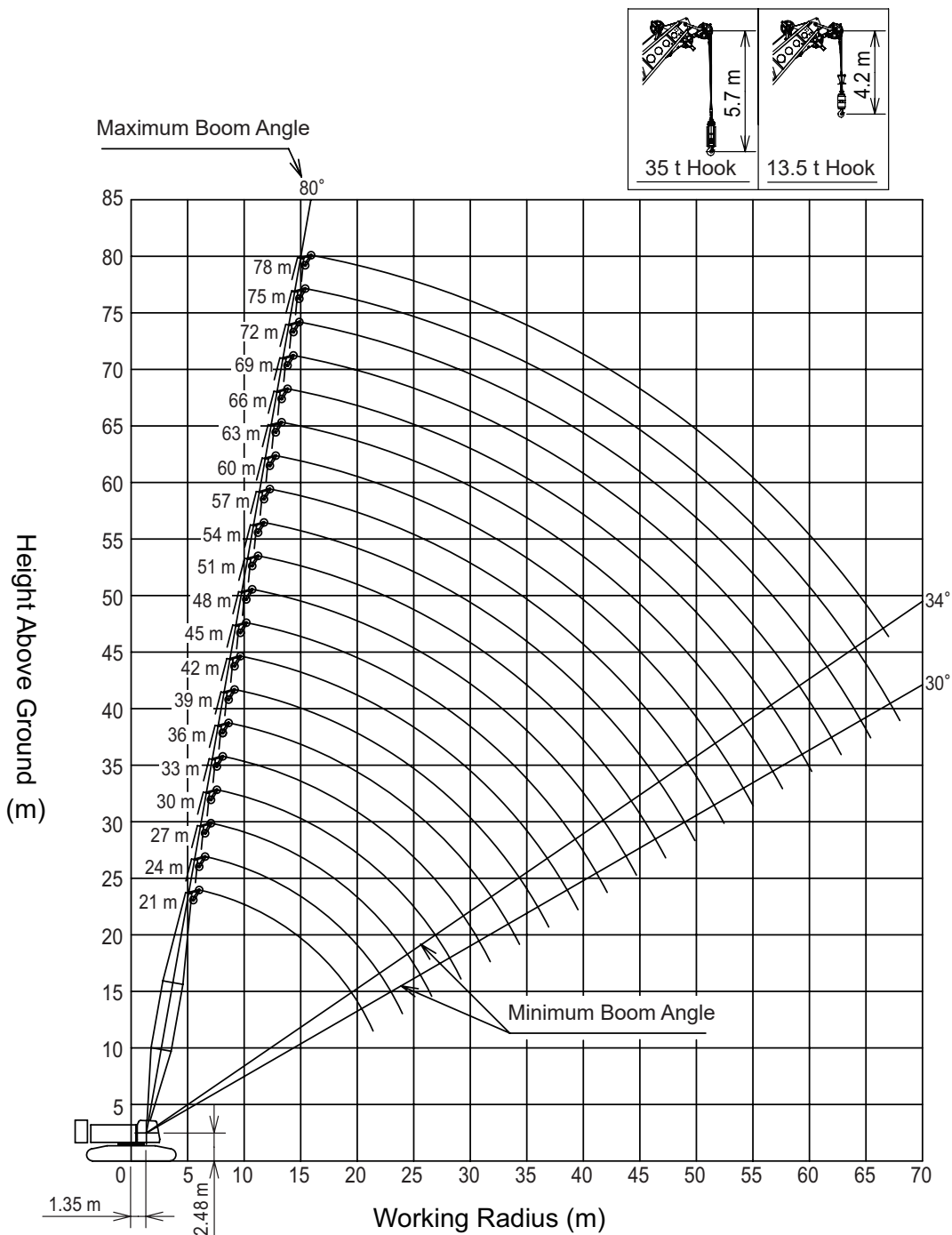

■ Crane Jib

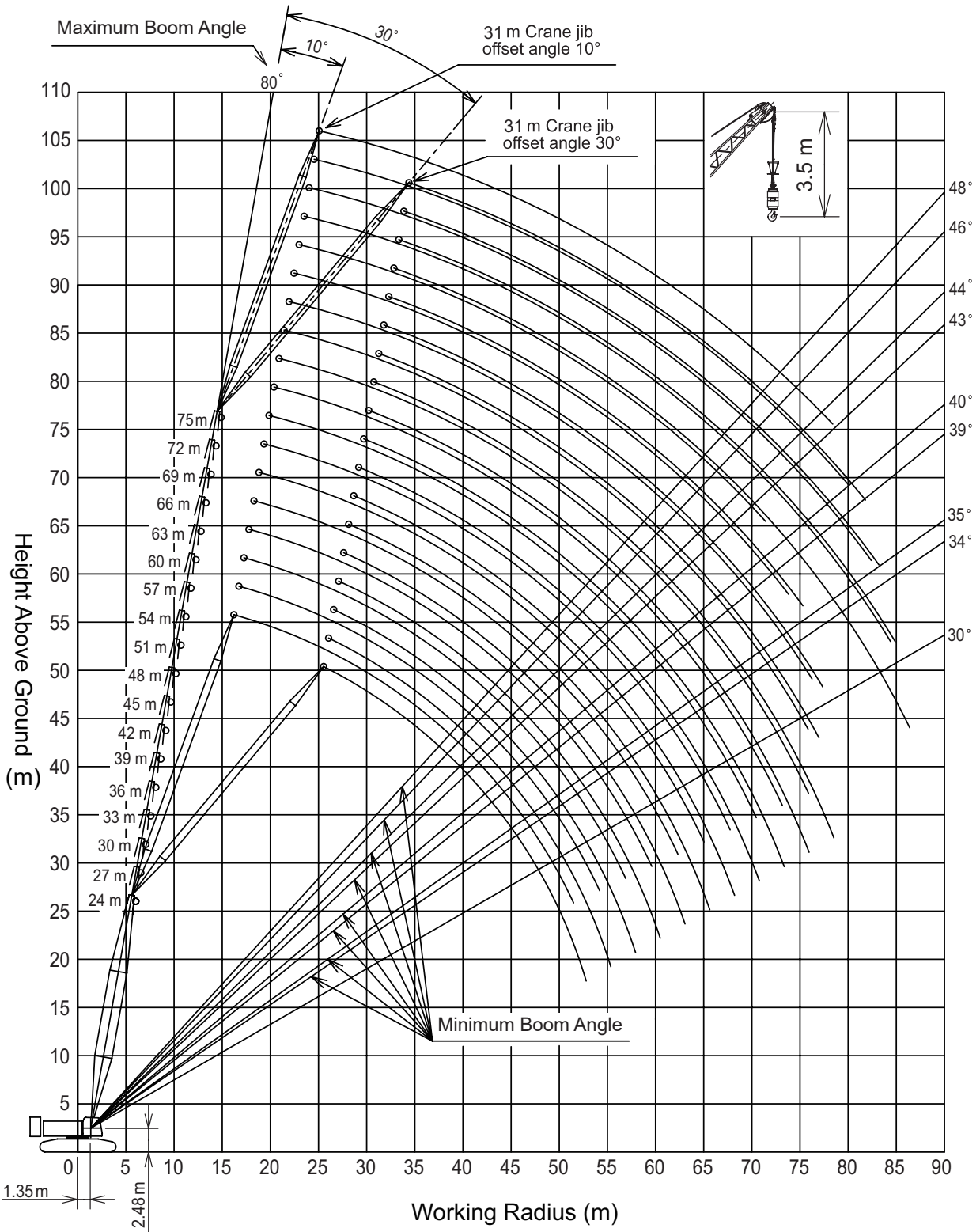

Gross Rated Load Table

HD Boom



Unit: ton

Working Radius (m)	Boom Length (m)
	12
4.1	175.0/180.0*
4.5	162.0
5	146.0
6	122.9
7	105.6
8	92.4
9	76.1
10	62.5
12	39.8

* 180 t lifting capacity is limited edition, and requires special equipment.

Main Boom

Unit: ton

Working Radius (m)	Boom Length (m)												Working Radius (m)	
	15	18	21	24	27	30	33	36	39	42	45	48		
4.5	160.0		5.5m x 132.0t											4.5
5	147.7	132.0		6.1m x 120.0t	6.6m x 108.0t									5
6	123.9	123.7	124.6			7.1m x 96.0t	7.6m x 84.0t							6
7	106.6	106.4	107.3	107.1	106.9			8.2m x 84.0t	8.7m x 72.0t					7
8	93.3	93.1	94.1	93.9	93.7	93.6	84.0			9.2m x 67.5t	9.7m x 60.0t			8
9	82.9	82.7	83.6	83.5	83.3	83.2	83.1	80.3	72.0			10.2m x 60.0t		9
10	74.5	74.3	75.2	75.1	74.8	74.8	74.6	74.4	72.0	67.5	60.0			10
12	56.6	61.5	62.5	62.3	62.1	62.0	61.9	61.6	59.8	59.7	59.4	56.1		12
14	40.0	51.1	52.2	52.1	52.0	52.0	51.9	51.7	50.9	50.7	50.5	48.0		14
16	14.5m x 36.2t	38.7	43.6	43.5	43.4	43.4	43.3	43.1	43.0	42.9	42.7	41.8		16
18		17.1m x 32.3t	37.3	37.2	37.1	37.0	36.9	36.7	36.7	36.5	36.4	36.2		18
20			19.7m x 29.9t	32.4	32.2	32.2	32.1	31.8	31.8	31.6	31.5	31.3		20
22				28.0	28.4	28.3	28.2	28.0	27.9	27.7	27.6	27.4		22
24				22.3m x 26.9t	25.3	25.2	25.1	24.9	24.8	24.6	24.5	24.3		24
26					24.9m x 24.1t	22.6	22.5	22.3	22.2	22.0	21.9	21.7		26
28						27.5m x 21.0t	20.4	20.1	20.0	19.9	19.7	19.5		28
30							18.5	18.3	18.2	18.0	17.8	17.7		30
32							30.1m x 18.4t	16.7	16.6	16.4	16.2	16.1		32
34								32.7m x 16.2t	15.2	15.0	14.9	14.7		34
36									35.3m x 14.4t	13.8	13.6	13.5		36
38										37.9m x 12.8t	12.6	12.4		38
40											11.6	11.4		40
42											40.5m x 11.4t	10.6		42
44												43.1m x 10.1t		44
46													10.1t	46

- The rated loads are determined according to EN13000 rating on the condition that the machine is stationed on firm level ground.
- The figures surrounded by bold lines are based on factors other than those which would cause a tipping condition.
- Be sure to attach the hanger sheaves block and balance weight to the top boom when boom length is 15m and 18m.
- Be sure to remove the balance weight from the top boom when boom length is 21m or more.
- Be sure to remove the hanger sheaves block from the top boom when boom length is 24m or more.
- To calculate the maximum load that can actually be lifted, deduct mass of all lifting accessories, such as hook, from figures shown above.
- Working radius is the horizontal distance from the swing center to the center of gravity of a lifted load.
- The counter weight is 83 ton. (Superstructure 67 ton + lower weight 16 ton)
- Figures described as OOm x OOt in the tables indicate "working radius" m x "rated load" ton.
- Correlation between the number of reeved lines, maximum rated loads, hook mass are shown in the table below.

Hook Capacity (t)	Hook Weight (t)	Maximum Rated Loads (t)												
		14 falls	13 falls	11 falls	10 falls	9 falls	8 falls	7 falls	6 falls	5 falls	4 falls	3 falls	2 falls	1 fall
175	3.34	175	160	148.5	135	121.5	108	94.5	81	67.5	54	40.5	27	-
160	2.59	-	160	148.5	135	121.5	108	94.5	81	67.5	54	40.5	27	-
135	2.35	-	-	-	135	121.5	108	94.5	81	67.5	54	40.5	27	-
80	1.35	-	-	-	-	-	-	-	80	67.5	54	40.5	27	-
35	1.07	-	-	-	-	-	-	-	-	-	-	35	27	-
13.5	0.62	-	-	-	-	-	-	-	-	-	-	-	-	13.5

- To calculate the rated load when the operation is being performed with a skywalk attached to the boom, deduct the value in chart below from the rated load shown above.

Boom Length (m)	15	18	21	24	27	30	33	36	39	42	45	48
Equivalent Mass (t)	0.1	0.1	0.1	0.1	0.2	0.2	0.2	0.2	0.3	0.3	0.3	0.3

Boom Length (m)	51	54	57	60	63	66	69	72	75	78	81	84
Equivalent Mass (t)	0.3	0.3	0.3	0.3	0.3	0.4	0.4	0.4	0.4	0.4	0.5	0.5

■ Main Boom



Unit: ton

Working Radius (m)	Boom Length (m)												Working Radius (m)	
	51	54	57	60	63	66	69	72	75	78	81	84		
9	10.8m x	11.3m x	11.8m x											9
10	48.0t	48.0t	48.0t	12.3m x	12.8m x	13.4m x	13.9m x							10
12	48.0	48.0	48.0	40.5t	36.0t	36.0t	35.7t	14.4m x	14.9m x	15.5m x				12
14	47.7	47.5	45.2	40.5	36.0	36.0	35.6	27.0t	27.0t	24.0t			16.6m x	14
16	41.5	41.3	39.5	39.2	36.0	36.0	33.7	27.0	27.0	24.0	22.3		17.5t	16
18	36.1	35.9	35.8	34.6	34.3	34.1	31.8	27.0	27.0	24.0	21.0		16.8	18
20	31.2	31.0	30.9	30.7	30.5	30.3	29.2	27.0	24.8	24.0	19.7		15.7	20
22	27.4	27.1	27.0	26.8	26.7	26.5	26.2	25.5	23.2	24.0	18.4		14.6	22
24	24.2	24.0	23.8	23.6	23.5	23.4	23.2	22.9	21.7	22.8	17.2		13.6	24
26	21.6	21.4	21.2	21.0	20.9	20.7	20.6	20.3	20.1	20.1	16.0		12.7	26
28	19.4	19.2	19.0	18.8	18.7	18.6	18.4	18.1	17.9	17.9	14.9		11.8	28
30	17.6	17.3	17.2	17.0	16.9	16.7	16.5	16.3	16.1	16.0	13.8		10.9	30
32	16.0	15.7	15.6	15.4	15.2	15.1	14.9	14.6	14.4	14.4	12.7		10.1	32
34	14.6	14.3	14.2	14.0	13.8	13.7	13.5	13.2	13.0	13.0	11.6		9.2	34
36	13.4	13.1	12.9	12.7	12.6	12.4	12.2	12.0	11.8	11.7	10.7		8.4	36
38	12.3	12.0	11.8	11.6	11.5	11.3	11.1	10.9	10.7	10.6	9.8		7.7	38
40	11.3	11.1	10.9	10.7	10.5	10.4	10.2	9.9	9.7	9.6	8.9		6.9	40
42	10.4	10.2	10.0	9.8	9.7	9.5	9.3	9.0	8.8	8.8	8.1		6.3	42
44	9.7	9.4	9.2	9.0	8.9	8.7	8.5	8.2	8.1	8.0	7.4		5.6	44
46	45.7m x	8.7	8.5	8.3	8.2	8.0	7.8	7.5	7.3	7.2	6.7		5.1	46
48	9.1t	8.1	7.9	7.7	7.5	7.3	7.1	6.9	6.7	6.6	6.0		4.5	48
50		48.3m x	7.3	7.1	6.9	6.7	6.5	6.3	6.1	6.0	5.5		4.0	50
52		8.0t	50.9m x	6.5	6.4	6.2	6.0	5.7	5.5	5.4	4.9		3.6	52
54			7.0t	53.5m x	5.9	5.7	5.5	5.2	5.0	4.9	4.4		3.1	54
56				6.2t	5.4	5.2	5.0	4.8	4.6	4.4	3.9		2.7	56
58					56.1m x	4.8	4.6	4.3	4.1	4.0	3.5		2.4	58
60					5.4t	58.7m x	4.2	4.0	3.8	3.6	3.0		2.0	60
62						4.7t	61.3m x	3.6	3.4	3.2	2.6		1.7	62
64							4.0t	63.9m x	3.0	2.9	2.3		62.1m x	64
66								3.3t	2.7	2.6	1.9		1.7t	66
68									66.5m x	2.2	67.5m x			68
70									2.6t	68.8m x	1.7t			70
72										2.1t				72

* For notes about the table above, refer to page 14.

■ Aux. Sheave (1 Sheave)



Unit : ton

Working Radius (m)	Boom Length (m)										Working Radius (m)	
	21	24	27	30	33	36	39	42	45	48		
6.7	13.5	7.2m x	7.7m x									6.7
7	13.5	13.5t	13.5t	8.2m x	8.8m x							7
8	13.5	13.5	13.5	13.5t	13.5t	9.3m x	9.8m x					8
9	13.5	13.5	13.5	13.5	13.5	13.5t	13.5t	10.3m x	10.8m x	11.4m x		9
10	13.5	13.5	13.5	13.5	13.5	13.5	13.5	13.5t	13.5t	13.5t		10
12	13.5	13.5	13.5	13.5	13.5	13.5	13.5	13.5	13.5	13.5		12
14	13.5	13.5	13.5	13.5	13.5	13.5	13.5	13.5	13.5	13.5		14
16	13.5	13.5	13.5	13.5	13.5	13.5	13.5	13.5	13.5	13.5		16
18	13.5	13.5	13.5	13.5	13.5	13.5	13.5	13.5	13.5	13.5		18
20	13.5	13.5	13.5	13.5	13.5	13.5	13.5	13.5	13.5	13.5		20
22	21.3m x	13.5	13.5	13.5	13.5	13.5	13.5	13.5	13.5	13.5		22
24	13.5t	23.9m x	13.5	13.5	13.5	13.5	13.5	13.5	13.5	13.5		24
26		13.5t	13.5	13.5	13.5	13.5	13.5	13.5	13.5	13.5		26
28			26.5m x	13.5	13.5	13.5	13.5	13.5	13.5	13.5		28
30			13.5t	29.1m x	13.5	13.5	13.5	13.5	13.5	13.5		30
32				13.5t	31.7m x	13.5	13.5	13.5	13.5	13.5		32
34					13.5t	13.5	13.5	13.5	13.5	13.5		34
36						34.3m x	13.5	13.5	13.4	13.3		36
38						13.5t	36.9m x	12.5	12.3	12.2		38
40							13.3t	39.5m x	11.4	11.2		40
42								11.8t	10.5	10.3		42
44									42.1m x	9.6		44
46									10.5t	44.7m x		46
48										9.3t		48

- The rated loads are determined according to EN13000 rating on the condition that the machine is stationed on firm level ground.
- The figures surrounded by bold lines are based on factors other than those which would cause a tipping condition.
- Be sure to attach the hanger sheaves block and balance weight to the top boom when boom length is 15m and 18m.
- Be sure to remove the balance weight from the top boom when boom length is 21m or more.
- Be sure to remove the hanger sheaves block from the top boom when boom length is 24m or more.
- To calculate the maximum load that can actually be lifted, deduct mass of all lifting accessories, such as hook, from figures shown above.
- Working radius is the horizontal distance from the swing center to the center of gravity of a lifted load.
- The counter weight is 83 ton. (Superstructure 67 ton + lower weight 16 ton)
- Figures described as OOm x OOt in the tables indicate "working radius" m x "rated load" ton.
- Hook mass are shown in the table below.

Hook Capacity (t)	Hook Weight (t)
160	2.59
135	2.35
80	1.35
35	1.07
13.5	0.62

- To calculate the rated load when the operation is being performed with a skywalk attached to the boom, deduct the value in chart below from the rated load shown above.

Boom Length (m)	15	18	21	24	27	30	33	36	39	42	45	48
Equivalent Mass (t)	0.1	0.1	0.1	0.1	0.2	0.2	0.2	0.2	0.3	0.3	0.3	0.3

Boom Length (m)	51	54	57	60	63	66	69	72	75	78
Equivalent Mass (t)	0.3	0.3	0.3	0.3	0.3	0.4	0.4	0.4	0.4	0.4

■ Aux. Sheave (1 Sheave)



Unit: ton

Working Radius (m)	Boom Length (m)										Working Radius (m)	
	51	54	57	60	63	66	69	72	75	78		
9	11.9m x											9
10	13.5t											10
12	13.5	12.4m x	12.9m x	13.4m x		14.5m x	15.0m x	15.5m x				12
14	13.5	13.5t	13.5t	13.5t		13.5t	13.5t	13.5t		16.1m x	16.6m x	14
16	13.5	13.5	13.5	13.5	13.5	13.5	13.5	13.5	13.5	13.5t	13.5t	16
18	13.5	13.5	13.5	13.5	13.5	13.5	13.5	13.5	13.5	13.5	13.5	18
20	13.5	13.5	13.5	13.5	13.5	13.5	13.5	13.5	13.5	13.5	13.5	20
22	13.5	13.5	13.5	13.5	13.5	13.5	13.5	13.5	13.5	13.5	13.5	22
24	13.5	13.5	13.5	13.5	13.5	13.5	13.5	13.5	13.5	13.5	13.5	24
26	13.5	13.5	13.5	13.5	13.5	13.5	13.5	13.5	13.5	13.5	13.5	26
28	13.5	13.5	13.5	13.5	13.5	13.5	13.5	13.5	13.5	13.5	13.5	28
30	13.5	13.5	13.5	13.5	13.5	13.5	13.5	13.5	13.5	13.5	13.5	30
32	13.5	13.5	13.5	13.5	13.5	13.5	13.5	13.5	13.5	13.5	13.0	32
34	13.5	13.5	13.5	13.5	13.5	13.5	13.4	13.2	13.0	12.8	12.2	34
36	13.1	12.9	12.7	12.5	12.4	12.2	12.0	11.7	11.5	11.3	11.3	36
38	12.0	11.8	11.6	11.4	11.3	11.1	10.9	10.6	10.4	10.4	10.4	38
40	11.1	10.8	10.6	10.4	10.3	10.1	9.9	9.6	9.4	9.4	9.4	40
42	10.2	9.9	9.7	9.5	9.4	9.2	9.0	8.7	8.5	8.5	8.5	42
44	9.4	9.2	9.0	8.7	8.6	8.4	8.2	7.9	7.7	7.7	7.7	44
46	8.7	8.4	8.2	8.0	7.9	7.7	7.5	7.2	7.0	7.0	7.0	46
48	47.3m x	7.8	7.6	7.4	7.2	7.0	6.8	6.6	6.4	6.3	6.3	48
50	8.3t	49.8m x	7.0	6.8	6.6	6.4	6.2	6.0	5.8	5.7	5.7	50
52		7.3t	6.5	6.3	6.1	5.9	5.7	5.4	5.2	5.1	5.1	52
54			52.4m x	5.8	5.6	5.4	5.2	4.9	4.7	4.6	4.6	54
56			6.4t	55.0m x	5.1	4.9	4.7	4.4	4.2	4.1	4.1	56
58				5.5t	57.6m x	4.5	4.3	4.0	3.8	3.7	3.7	58
60					4.8t	4.1	3.9	3.6	3.4	3.3	3.3	60
62						60.2m x	3.5	3.3	3.0	2.9	2.9	62
64						4.1t	62.8m x	2.9	2.7	2.6	2.6	64
66							3.4t	65.4m x	2.4	2.3	2.3	66
68								2.7t	2.1	1.9	1.9	68
70										68.6m x	1.9t	70
72										1.9t	1.9t	72

* For notes about the table above, refer to page 16.

■ Aux. Sheave (2 Sheaves)



Unit: ton

Working Radius (m)	Boom Length (m)										Working Radius (m)	
	21	24	27	30	33	36	39	42	45	48		
		6.9m x 27.0t										
6.4	27.0	27.0t	7.4m x 27.0t									6.4
7	27.0	27.0	27.0		8.5m x 27.0t							7
8	27.0	27.0	27.0	27.0	27.0		9.5m x 27.0t					8
9	27.0	27.0	27.0	27.0	27.0	27.0	27.0					9
10	27.0	27.0	27.0	27.0	27.0	27.0	27.0	27.0	10.6m x 27.0t	11.1m x 27.0t		10
12	27.0	27.0	27.0	27.0	27.0	27.0	27.0	27.0	27.0	27.0		12
14	27.0	27.0	27.0	27.0	27.0	27.0	27.0	27.0	27.0	27.0		14
16	27.0	27.0	27.0	27.0	27.0	27.0	27.0	27.0	27.0	27.0		16
18	27.0	27.0	27.0	27.0	27.0	27.0	27.0	27.0	27.0	27.0		18
20	27.0	27.0	27.0	27.0	27.0	27.0	27.0	27.0	27.0	27.0		20
22	21.1m x 27.0t	27.0	27.0	27.0	27.0	27.0	27.0	27.0	27.0	27.0		22
24		23.7m x 25.5t	24.9	24.8	24.7	24.5	24.4	24.2	24.1	23.9		24
26			22.3	22.3	22.1	21.9	21.8	21.6	21.4	21.3		26
28			26.3m x 22.0t	20.1	20.0	19.7	19.6	19.4	19.3	19.1		28
30				28.9m x 19.2t	18.1	17.9	17.8	17.6	17.4	17.2		30
32					31.5m x 16.9t	16.3	16.2	16.0	15.8	15.6		32
34						14.9	14.8	14.6	14.4	14.2		34
36						34.1m x 14.8t	13.6	13.4	13.2	13.0		36
38							36.7m x 13.2t	12.3	12.1	11.9		38
40								39.3m x 11.6t	11.1	10.9		40
42									41.9m x 10.3t	10.1		42
44										9.3		44
46										44.5m x 9.1t		46
48												48

- The rated loads are determined according to EN13000 rating on the condition that the machine is stationed on firm level ground.
- The figures surrounded by bold lines are based on factors other than those which would cause a tipping condition.
- Be sure to attach the hanger sheaves block and balance weight to the top boom when boom length is 15m and 18m.
- Be sure to remove the balance weight from the top boom when boom length is 21m or more.
- Be sure to remove the hanger sheaves block from the top boom when boom length is 24m or more.
- To calculate the maximum load that can actually be lifted, deduct mass of all lifting accessories, such as hook, from figures shown above.
- Working radius is the horizontal distance from the swing center to the center of gravity of a lifted load.
- The counter weight is 83 ton. (Superstructure 67 ton + lower weight 16 ton)
- Figures described as OOm x OOt in the tables indicate "working radius" m x "rated load" ton.
- Hook mass are shown in the table below.

Hook Capacity (t)	Hook Weight (t)
160	2.59
135	2.35
80	1.35
35	1.07
13.5	0.62

- To calculate the rated load when the operation is being performed with a skywalk attached to the boom, deduct the value in chart below from the rated load shown above.

Boom Length (m)	15	18	21	24	27	30	33	36	39	42	45	48
Equivalent Mass (t)	0.1	0.1	0.1	0.1	0.2	0.2	0.2	0.2	0.3	0.3	0.3	0.3

Boom Length (m)	51	54	57	60	63	66	69	72	75	78
Equivalent Mass (t)	0.3	0.3	0.3	0.3	0.3	0.4	0.4	0.4	0.4	0.4

■ Aux. Sheave (2 Sheaves)



Unit: ton

Working Radius (m)	Boom Length (m)										Working Radius (m)	
	51	54	57	60	63	66	69	72	75	78		
9	11.6m x											9
10	27.0t											10
12	27.0	12.1m x	12.6m x	13.2m x	13.7m x							12
14	27.0	27.0t	27.0t	27.0t	27.0t	14.2m x	14.7m x	15.2m x	15.8m x			14
16	27.0	27.0	27.0	27.0	27.0	27.0t	13.5t	13.5t	13.5t	16.3m x		16
18	27.0	27.0	27.0	27.0	27.0	27.0	13.5	13.5	13.5	13.5t		18
20	27.0	27.0	27.0	27.0	27.0	26.0	13.5	13.5	13.5	13.5		20
22	27.0	26.7	26.5	26.4	26.3	24.7	13.5	13.5	13.5	13.5		22
24	23.8	23.6	23.4	23.2	23.1	22.9	13.5	13.5	13.5	13.5		24
26	21.2	20.9	20.8	20.6	20.4	20.3	13.5	13.5	13.5	13.5		26
28	19.0	18.7	18.5	18.3	18.2	18.0	13.5	13.5	13.5	13.5		28
30	17.1	16.9	16.7	16.5	16.4	16.2	13.5	13.5	13.5	13.5		30
32	15.5	15.2	15.1	14.8	14.7	14.5	13.5	13.5	13.5	12.6		32
34	14.1	13.8	13.6	13.4	13.3	13.1	12.9	12.7	12.5	11.8		34
36	12.9	12.6	12.4	12.2	12.1	11.9	11.7	11.4	11.2	11.1		36
38	11.8	11.5	11.3	11.1	11.0	10.8	10.6	10.3	10.1	10.1		38
40	10.8	10.5	10.3	10.1	10.0	9.8	9.6	9.3	9.1	9.1		40
42	9.9	9.7	9.5	9.3	9.1	8.9	8.7	8.5	8.3	8.2		42
44	9.1	8.9	8.7	8.5	8.3	8.1	7.9	7.7	7.5	7.4		44
46	8.4	8.2	8.0	7.8	7.6	7.4	7.2	6.9	6.7	6.7		46
48	47.1m x	7.5	7.3	7.1	7.0	6.8	6.5	6.3	6.1	6.0		48
50	8.1t	49.7m x	6.8	6.5	6.4	6.2	5.9	5.7	5.5	5.4		50
52		7.0t	6.2	6.0	5.8	5.6	5.4	5.1	4.9	4.9		52
54			52.3m x	5.5	5.3	5.1	4.9	4.6	4.4	4.3		54
56			6.1t	54.9m x	4.9	4.7	4.4	4.2	4.0	3.9		56
58				5.3t	57.5m x	4.2	4.0	3.8	3.5	3.4		58
60					4.5t	3.8	3.6	3.4	3.1	3.0		60
62						60.1m x	3.3	3.0	2.8	2.7		62
64						3.8t	62.7m x	2.7	2.4	2.3		64
66							3.1t	65.2m x	2.1	2.0		66
68								2.5t	67.8m x	66.9m x		68
70									1.9t	1.9t		70

* For notes about the table above, refer to page 18.

■ Main Boom with Aux. Sheave



Unit: ton

Working Radius (m)	Boom Length (m)										Working Radius (m)	
	21	24	27	30	33	36	39	42	45	48		
5.5	120.0	6.1m x	6.6m x									5.5
6	120.0	120.0t	108.0t	7.1m x	7.6m x							6
7	106.5	106.3	106.1	96.0t	84.0t	8.2m x	8.7m x					7
8	93.3	93.1	92.9	92.8	84.0	84.0t	72.0t	9.2m x	9.7m x			8
9	82.9	82.7	82.5	82.4	82.3	79.8	72.0	67.5t	60.0t	10.2m x		9
10	74.5	74.3	74.1	74.0	73.9	73.6	71.6	67.5	60.0	60.0t		10
12	61.7	61.6	61.4	61.3	61.1	60.8	59.3	59.1	58.8	55.5		12
14	51.8	51.8	51.6	51.6	51.5	51.3	50.4	50.2	49.9	47.4		14
16	43.2	43.2	43.0	43.0	42.9	42.7	42.6	42.4	42.3	41.2		16
18	36.9	36.8	36.7	36.6	36.5	36.3	36.2	36.0	35.9	35.7		18
20	19.7m x	32.0	31.8	31.8	31.7	31.4	31.4	31.2	31.0	30.9		20
22	29.2t	27.3	28.0	27.9	27.8	27.6	27.5	27.3	27.2	27.0		22
24		22.3m x	24.9	24.8	24.7	24.5	24.4	24.2	24.0	23.9		24
26		26.2t	24.9m x	22.3	22.1	21.9	21.8	21.6	21.4	21.3		26
28			23.6t	27.5m x	20.0	19.7	19.6	19.4	19.3	19.1		28
30				20.6t	18.2	17.9	17.8	17.6	17.4	17.2		30
32					30.1m x	16.3	16.2	16.0	15.8	15.6		32
34					18.1t	32.7m x	14.8	14.6	14.4	14.3		34
36						15.8t	35.3m x	13.4	13.2	13.0		36
38							14.0t	37.9m x	12.2	12.0		38
40								12.4t	11.2	11.0		40
42									40.5m x	10.2		42
44									11.0t	43.1m x		44
46										9.7t		46

- The rated loads are determined according to EN13000 rating on the condition that the machine is stationed on firm level ground.
- The figures surrounded by bold lines are based on factors other than those which would cause a tipping condition.
- Be sure to attach the hanger sheaves block and balance weight to the top boom when boom length is 15m and 18m.
- Be sure to remove the balance weight from the top boom when boom length is 21m or more.
- Be sure to remove the hanger sheaves block from the top boom when boom length is 24m or more.
- To calculate the maximum load that can actually be lifted, deduct mass of all lifting accessories, such as hook, from figures shown above.
- Working radius is the horizontal distance from the swing center to the center of gravity of a lifted load.
- The counter weight is 83 ton. (Superstructure 67 ton + lower weight 16 ton)
- Figures described as OOm x OOt in the tables indicate "working radius" m x "rated load" ton.
- Correlation between the number of reeved lines, maximum rated loads, hook mass are shown in the table below.

Hook Capacity (t)	Hook Weight (t)	Maximum Rated Loads (t)									
		10 falls	9 falls	8 falls	7 falls	6 falls	5 falls	4 falls	3 falls	2 falls	1 fall
135	2.35	135	121.5	108	94.5	81	67.5	54	40.5	27	-
80	1.35	-	-	-	-	80	67.5	54	40.5	27	-
35	1.07	-	-	-	-	-	-	-	35	27	-
13.5	0.62	-	-	-	-	-	-	-	-	-	13.5

- To calculate the rated load when the operation is being performed with a skywalk attached to the boom, deduct the value in chart below from the rated load shown above.

Boom Length (m)	15	18	21	24	27	30	33	36	39	42	45	48
Equivalent Mass (t)	0.1	0.1	0.1	0.1	0.2	0.2	0.2	0.2	0.3	0.3	0.3	0.3

Boom Length (m)	51	54	57	60	63	66	69	72	75	78
Equivalent Mass (t)	0.3	0.3	0.3	0.3	0.3	0.4	0.4	0.4	0.4	0.4

■ Main Boom with Aux. Sheave



Unit: ton

Working Radius (m)	Boom Length (m)										Working Radius (m)	
	51	54	57	60	63	66	69	72	75	78		
9	10.8m x	11.3m x	11.8m x									9
10	48.0t	48.0t	48.0t									10
12	48.0	48.0	48.0	12.3m x	12.8m x	13.4m x	13.9m x					12
14	47.2	46.9	44.6	40.5t	36.0t	36.0t	34.6t	14.4m x	14.9m x	15.5m x		14
16	40.9	40.7	38.9	38.6	36.0	35.8	32.7	27.0	27.0	23.7		16
18	35.7	35.4	35.3	34.0	33.7	33.4	30.8	27.0	25.4	22.2		18
20	30.8	30.5	30.4	30.2	29.9	29.7	28.5	26.2	23.8	20.8		20
22	26.9	26.7	26.5	26.3	26.2	26.0	25.6	24.5	22.2	19.4		22
24	23.8	23.5	23.3	23.1	23.0	22.8	22.6	22.4	20.7	18.1		24
26	21.2	20.9	20.7	20.5	20.4	20.2	20.0	19.8	19.3	16.9		26
28	19.0	18.7	18.6	18.3	18.2	18.0	17.8	17.6	17.4	15.6		28
30	17.1	16.9	16.7	16.5	16.4	16.2	16.0	15.7	15.5	14.4		30
32	15.5	15.3	15.1	14.9	14.8	14.6	14.4	14.1	13.9	13.2		32
34	14.1	13.9	13.7	13.5	13.4	13.2	13.0	12.7	12.5	12.1		34
36	12.9	12.7	12.5	12.3	12.1	11.9	11.7	11.5	11.3	11.1		36
38	11.8	11.6	11.4	11.2	11.0	10.8	10.6	10.4	10.2	10.1		38
40	10.9	10.6	10.4	10.2	10.1	9.9	9.7	9.4	9.2	9.1		40
42	10.0	9.8	9.6	9.3	9.2	9.0	8.8	8.5	8.3	8.2		42
44	9.3	9.0	8.8	8.6	8.4	8.2	8.0	7.7	7.5	7.4		44
46	45.7m x	8.3	8.1	7.9	7.7	7.5	7.3	7.0	6.8	6.7		46
48	8.7t	7.7	7.5	7.2	7.1	6.9	6.6	6.4	6.2	6.1		48
50		48.3m x	6.9	6.7	6.5	6.3	6.1	5.8	5.6	5.5		50
52		7.6t	50.9m x	6.1	5.9	5.7	5.5	5.3	5.0	4.9		52
54			6.6t	53.5m x	5.4	5.2	5.0	4.8	4.5	4.4		54
56				5.8t	5.0	4.8	4.6	4.3	4.1	3.9		56
58					56.1m x	4.4	4.1	3.9	3.7	3.5		58
60					5.0t	58.7m x	3.8	3.5	3.3	3.1		60
62						4.2t	61.3m x	3.1	2.9	2.7		62
64							3.5t	63.9m x	2.6	2.3		64
66								2.8t	2.3	2.0		66
68									66.5m x	66.5m x		68
70									2.2t	1.9t		70

* For notes about the table above, refer to page 20.

■ Main Boom with Aux. Sheave (2 Sheaves)



Unit: ton

Working Radius (m)	Boom Length (m)										Working Radius (m)	
	21	24	27	30	33	36	39	42	45	48		
5.5	120.0	6.1m x	6.6m x									5.5
6	120.0	120.0t	108.0t	7.1m x	7.6m x							6
7	106.3	106.1	105.9	96.0t	84.0t	8.2m x	8.7m x					7
8	93.1	92.9	92.7	92.6	84.0	84.0t	72.0t	9.2m x	9.7m x			8
9	82.7	82.5	82.3	82.2	82.1	79.6	72.0	67.5t	60.0t	10.2m x		9
10	74.3	74.1	73.9	73.8	73.7	73.4	71.3	67.5	60.0	60.0t		10
12	61.5	61.4	61.1	61.0	60.9	60.6	59.1	58.9	58.5	55.3		12
14	51.6	51.5	51.4	51.3	51.3	51.1	50.2	50.0	49.6	47.2		14
16	43.0	42.9	42.8	42.7	42.6	42.4	42.4	42.2	42.1	41.0		16
18	36.5	36.6	36.4	36.4	36.3	36.1	36.0	35.8	35.7	35.5		18
20	19.7m x	31.8	31.6	31.5	31.4	31.2	31.1	30.9	30.8	30.6		20
22	28.7t	27.1	27.8	27.7	27.6	27.3	27.3	27.1	26.9	26.7		22
24		22.3m x	24.7	24.6	24.5	24.2	24.1	23.9	23.8	23.6		24
26		26.0t	24.9m x	22.0	21.9	21.7	21.6	21.4	21.2	21.0		26
28			23.3t	27.5m x	19.8	19.5	19.4	19.2	19.0	18.9		28
30				20.4t	17.9	17.7	17.6	17.4	17.2	17.0		30
32					30.1m x	16.1	16.0	15.8	15.6	15.4		32
34					17.8t	32.7m x	14.6	14.4	14.2	14.0		34
36						15.6t	35.3m x	13.2	13.0	12.8		36
38							13.8t	37.9m x	11.9	11.7		38
40								12.2t	11.0	10.8		40
42									40.5m x	9.9		42
44									10.8t	43.1m x		44
46										9.5t		46

- The rated loads are determined according to EN13000 rating on the condition that the machine is stationed on firm level ground.
- The figures surrounded by bold lines are based on factors other than those which would cause a tipping condition.
- Be sure to attach the hanger sheaves block and balance weight to the top boom when boom length is 15m and 18m.
- Be sure to remove the balance weight from the top boom when boom length is 21m or more.
- Be sure to remove the hanger sheaves block from the top boom when boom length is 24m or more.
- To calculate the maximum load that can actually be lifted, deduct mass of all lifting accessories, such as hook, from figures shown above.
- Working radius is the horizontal distance from the swing center to the center of gravity of a lifted load.
- The counter weight is 83 ton. (Superstructure 67 ton + lower weight 16 ton)
- Figures described as OOm x OOt in the tables indicate "working radius" m x "rated load" ton.
- Correlation between the number of reeved lines, maximum rated loads, hook mass are shown in the table below.

Hook Capacity (t)	Hook Weight (t)	Maximum Rated Loads (t)									
		10 falls	9 falls	8 falls	7 falls	6 falls	5 falls	4 falls	3 falls	2 falls	1 fall
135	2.35	135	121.5	108	94.5	81	67.5	54	40.5	27	-
80	1.35	-	-	-	-	80	67.5	54	40.5	27	-
35	1.07	-	-	-	-	-	-	-	35	27	-
13.5	0.62	-	-	-	-	-	-	-	-	-	13.5

- To calculate the rated load when the operation is being performed with a skywalk attached to the boom, deduct the value in chart below from the rated load shown above.

Boom Length (m)	15	18	21	24	27	30	33	36	39	42	45	48
Equivalent Mass (t)	0.1	0.1	0.1	0.1	0.2	0.2	0.2	0.2	0.3	0.3	0.3	0.3

Boom Length (m)	51	54	57	60	63	66	69	72	75	78
Equivalent Mass (t)	0.3	0.3	0.3	0.3	0.3	0.4	0.4	0.4	0.4	0.4

■ Main Boom with Aux. Sheave (2 Sheaves)



Unit: ton

Working Radius (m)	Boom Length (m)										Working Radius (m)	
	51	54	57	60	63	66	69	72	75	78		
9	10.8m x	11.3m x	11.8m x									9
10	48.0t	48.0t	48.0t									10
12	48.0	48.0	48.0	12.3m x	12.8m x	13.4m x	13.9m x					12
14	46.9	46.6	44.4	40.5t	36.0t	36.0t	34.3t	14.4m x	14.9m x	15.5m x		14
16	40.7	40.4	38.6	38.4	36.0	35.5	32.4	27.0	26.7	23.4		16
18	35.4	35.2	35.0	33.8	33.4	33.2	30.5	27.0	25.1	22.0		18
20	30.5	30.3	30.1	29.9	29.7	29.4	28.3	25.9	23.5	20.6		20
22	26.7	26.4	26.2	26.0	25.9	25.8	25.3	24.2	21.9	19.2		22
24	23.5	23.3	23.1	22.9	22.8	22.6	22.4	22.2	20.5	17.9		24
26	20.9	20.7	20.5	20.3	20.2	20.0	19.8	19.6	19.0	16.6		26
28	18.7	18.5	18.3	18.1	18.0	17.8	17.6	17.4	17.2	15.4		28
30	16.9	16.6	16.5	16.2	16.1	15.9	15.7	15.5	15.3	14.2		30
32	15.3	15.0	14.9	14.6	14.5	14.3	14.1	13.9	13.7	13.0		32
34	13.9	13.6	13.5	13.2	13.1	12.9	12.7	12.5	12.3	11.9		34
36	12.7	12.4	12.2	12.0	11.9	11.7	11.5	11.2	11.0	10.9		36
38	11.6	11.3	11.2	10.9	10.8	10.6	10.4	10.1	9.9	9.8		38
40	10.6	10.4	10.2	10.0	9.8	9.6	9.4	9.2	9.0	8.9		40
42	9.8	9.5	9.3	9.1	9.0	8.8	8.5	8.3	8.1	8.0		42
44	9.0	8.7	8.5	8.3	8.2	8.0	7.8	7.5	7.3	7.2		44
46	45.7m x	8.1	7.8	7.6	7.5	7.3	7.1	6.8	6.6	6.5		46
48	8.4t	7.4	7.2	7.0	6.8	6.6	6.4	6.1	5.9	5.8		48
50		48.3m x	6.6	6.4	6.2	6.0	5.8	5.6	5.3	5.2		50
52		7.3t	50.9m x	5.9	5.7	5.5	5.3	5.0	4.8	4.7		52
54			6.4t	53.5m x	5.2	5.0	4.8	4.5	4.3	4.2		54
56				5.5t	4.8	4.6	4.3	4.1	3.9	3.7		56
58					56.1m x	4.1	3.9	3.6	3.4	3.3		58
60					4.7t	58.7m x	3.5	3.3	3.0	2.9		60
62						4.0t	61.3m x	2.9	2.7	2.5		62
64							3.3t	63.9m x	2.3	2.1		64
66								2.6t	2.0	65.3m x		66
68									66.5m x	1.9t		68
70									2.0t			70

* For notes about the table above, refer to page 22.

■ Crane Jib



Unit: ton

Boom Length (m)	24								Boom Length (m)
Jib Length (m)	13		19		25		31		Jib Length (m)
Offset Angle (°)	10		30		10		30		Offset Angle (°)
Working Radius (m)	10		30		10		30		Working Radius (m)
10.4	12.0		12.4m x						10.4
12	12.0		11.9t		14.5m x				12
14	12.0	10.2	11.8		8.4t		16.5m x		14
16	12.0	9.7	11.6	18.2m x	8.3		5.8t		16
18	12.0	9.2	11.3	7.6t	8.0		5.7		18
20	12.0	8.8	11.0	7.3	7.8		5.5		20
22	12.0	8.3	10.7	6.9	7.6	6.0	5.3	25.9m x	22
24	12.0	8.0	10.4	6.6	7.3	5.7	5.1	3.9t	24
26	12.0	7.7	10.2	6.3	7.1	5.4	4.9	4.0	26
28	12.0	7.4	10.0	6.0	6.9	5.2	4.7	3.8	28
30	12.0	7.2	9.8	5.8	6.7	4.9	4.5	3.7	30
32	11.6	7.0	9.6	5.6	6.5	4.7	4.4	3.6	32
34	11.0	6.8	9.0	5.4	6.3	4.5	4.2	3.5	34
36	35.1m x	35.8m x	8.6	5.2	6.2	4.4	4.1	3.4	36
38	10.7t	6.7t	8.1	5.1	6.0	4.2	3.9	3.3	38
40			7.7	5.0	5.9	4.1	3.8	3.2	40
42			40.7m x	41.8m x	5.8	4.0	3.7	3.1	42
44			7.6t	4.9t	5.6	3.9	3.5	3.1	44
46					5.5	3.8	3.5	3.0	46
48					46.3m x	47.8m x	3.4	3.0	48
50					5.4t	3.7t	3.3	2.9	50
52							3.1	2.9	52
54								53.8m x	54
56								2.9t	56

- The rated loads are determined according to EN13000 rating on the condition that the machine is stationed on firm level ground.
- The figures surrounded by bold lines are based on factors other than those which would cause a tipping condition.
- To calculate the maximum load that can actually be lifted, deduct mass of all lifting accessories, such as hook, from figures shown above.
- Working radius is the horizontal distance from the swing center to the center of gravity of a lifted load.
- The counter weight is 83 ton. (Superstructure 67 ton + lower weight 16 ton)
- Figures described as OOm x OOt in the tables indicate "working radius" m x "rated load" ton.
- Hook mass are shown in the table below.

Hook Capacity (t)	Hook Weight (t)
160	2.59
135	2.35
80	1.35
35	1.07
13.5	0.62

- To calculate the rated load when the operation is being performed with a skywalk attached to the boom, deduct the value in chart below from the rated load shown above.

Boom Length (m)	24	27	30	33	36	39	42
Equivalent Mass (t)	0.1	0.2	0.2	0.2	0.2	0.3	0.3

Boom Length (m)	45	48	51	54	57	60	63
Equivalent Mass (t)	0.3	0.3	0.3	0.3	0.3	0.3	0.3

Boom Length (m)	66	69	72	75
Equivalent Mass (t)	0.4	0.4	0.4	0.4

■ Crane Jib



Unit: ton

Boom Length (m)	27								Boom Length (m)
Jib Length (m)	13		19		25		31		Jib Length (m)
Offset Angle (°)	10	30	10	30	10	30	10	30	Offset Angle (°)
Working Radius (m)									Working Radius (m)
10	10.9m x 12.0t		13.0m x 11.9t						10
12	12.0	14.8m x 10.2t			15.0m x 8.4t				12
14	12.0		11.9				17.1m x 5.8t		14
16	12.0	9.9	11.6	18.7m x 7.6t	8.3				16
18	12.0	9.4	11.4	7.6t	8.1				18
20	12.0	8.9	11.2	7.4	7.9	22.5m x 5.9t			20
22	12.0	8.5	10.9	7.0	7.7	5.4			22
24	12.0	8.2	10.7	6.7	7.5	5.8		26.4m x 3.9t	24
26	12.0	7.9	10.4	6.4	7.3	5.5	5.0		26
28	12.0	7.6	10.1	6.2	7.1	5.2	4.8		28
30	12.0	7.3	9.9	5.9	6.9	5.0	4.7		30
32	12.0	7.1	9.7	5.7	6.7	4.8	4.5		32
34	11.7	7.0	9.6	5.5	6.5	4.6	4.3		34
36	11.1	6.8	9.1	5.4	6.3	4.5	4.2		36
38	37.7m x 10.6t		8.6	5.2	6.2	4.3	4.0		38
40		38.4m x 6.7t	8.2	5.1	6.0	4.2	3.9		40
42			7.8	5.0	5.9	4.1	3.8		42
44			43.3m x 7.6t	4.9	5.8	4.0	3.7		44
46				44.4m x 4.9t	5.7	3.9	3.6		46
48					5.5	3.8	3.4		48
50					48.9m x 5.4t	3.8	3.4		50
52						50.4m x 3.7t	3.3		52
54							3.2		54
56							54.6m x 3.1t		56
58								56.4m x 2.9t	58
60									60

Unit: ton

Boom Length (m)	30								Boom Length (m)
Jib Length (m)	13		19		25		31		Jib Length (m)
Offset Angle (°)	10	30	10	30	10	30	10	30	Offset Angle (°)
Working Radius (m)									Working Radius (m)
10	11.4m x 12.0t		13.5m x 11.9t						10
12	12.0	15.3m x 10.1t			15.5m x 8.4t				12
14	12.0		11.9				17.6m x 5.8t		14
16	12.0	10.0	11.7	19.2m x 7.6t	8.4				16
18	12.0	9.5	11.5	7.6t	8.1				18
20	12.0	9.1	11.2	7.5	7.9	23.1m x 5.9t			20
22	12.0	8.7	11.0	7.1	7.7	5.4			22
24	12.0	8.4	10.7	6.8	7.5	5.8		26.9m x 3.9t	24
26	12.0	8.1	10.5	6.5	7.3	5.6	5.1		26
28	12.0	7.8	10.3	6.3	7.2	5.3	4.9		28
30	12.0	7.5	10.2	6.0	7.0	5.1	4.7		30
32	12.0	7.3	10.0	5.8	6.8	4.9	4.6		32
34	12.0	7.1	9.7	5.6	6.6	4.7	4.4		34
36	11.7	7.0	9.5	5.5	6.5	4.6	4.3		36
38	11.2	6.8	9.1	5.3	6.3	4.4	4.2		38
40	10.7	6.7	8.6	5.2	6.2	4.3	4.0		40
42	40.3m x 10.6t	41.0m x 6.7t	8.2	5.1	6.0	4.2	3.9		42
44			7.9	5.0	5.9	4.0	3.8		44
46			45.9m x 7.5t	4.9	5.8	3.9	3.7		46
48				47.0m x 4.9t	5.7	3.9	3.6		48
50					5.6	3.8	3.5		50
52					51.5m x 5.4t	3.8	3.4		52
54						53.0m x 3.7t	3.3		54
56							3.3		56
58							57.2m x 3.1t		58
60								59.0m x 2.9t	60
62									62

* For notes about the table above, refer to page 24.

Crane Jib



Unit: ton

Boom Length (m)	33								Boom Length (m)
Jib Length (m)	13		19		25		31		Jib Length (m)
Offset Angle (°)	10	30	10	30	10	30	10	30	Offset Angle (°)
Working Radius (m)									Working Radius (m)
12	12.0	15.9m x							12
14	12.0	10.1t	12.0		16.1m x				14
16	12.0	10.1	11.8	19.7m x	8.4t		18.1m x		16
18	12.0	9.7	11.6	7.6t	8.2		5.8t		18
20	12.0	9.2	11.4	7.6	8.0	23.6m x	5.7		20
22	12.0	8.9	11.1	7.2	7.8	5.9t	5.5		22
24	12.0	8.5	10.8	6.9	7.6	5.9	5.3	27.4m x	24
26	12.0	8.2	10.6	6.6	7.4	5.6	5.2	3.9t	26
28	12.0	7.9	10.4	6.4	7.2	5.4	5.0	3.9	28
30	12.0	7.7	10.2	6.2	7.1	5.2	4.8	3.8	30
32	12.0	7.5	10.0	6.0	6.9	5.0	4.7	3.7	32
34	12.0	7.3	9.9	5.8	6.7	4.8	4.5	3.6	34
36	12.0	7.1	9.8	5.6	6.6	4.7	4.4	3.5	36
38	11.8	6.9	9.5	5.4	6.4	4.5	4.2	3.4	38
40	11.3	6.8	9.1	5.3	6.3	4.4	4.1	3.4	40
42	10.9	6.7	8.7	5.2	6.2	4.2	4.0	3.3	42
44	42.9m x	43.6m x	8.3	5.1	6.0	4.1	3.9	3.2	44
46	10.6t	6.6t	8.0	5.0	5.9	4.0	3.8	3.1	46
48			7.7	4.9	5.8	3.9	3.7	3.1	48
50			48.5m x	49.6m x	5.7	3.9	3.5	3.0	50
52			7.5t	4.9t	5.6	3.8	3.5	3.0	52
54					5.4	3.8	3.4	2.9	54
56					54.1m x	55.6m x	3.3	2.9	56
58					5.4t	3.7t	3.2	2.9	58
60							59.8m x	2.9	60
62							3.2t	61.6m x	62
64								2.9t	64

Unit: ton

Boom Length (m)	36								Boom Length (m)
Jib Length (m)	13		19		25		31		Jib Length (m)
Offset Angle (°)	10	30	10	30	10	30	10	30	Offset Angle (°)
Working Radius (m)									Working Radius (m)
10	12.5m x								10
12	12.0t		14.5m x						12
14	12.0	16.4m x	11.9t		16.6m x				14
16	12.0	10.1t	11.8		8.4t		18.6m x		16
18	12.0	9.8	11.6	20.2m x	8.3		5.8t		18
20	12.0	9.4	11.4	7.6t	8.1		5.7		20
22	12.0	9.0	11.2	7.3	7.9	24.1m x	5.6		22
24	12.0	8.7	11.0	7.0	7.7	5.9t	5.4		24
26	12.0	8.4	10.8	6.7	7.5	5.7	5.2		26
28	12.0	8.1	10.5	6.5	7.3	5.5	5.1	4.0	28
30	12.0	7.9	10.3	6.3	7.2	5.3	4.9	3.9	30
32	12.0	7.6	10.2	6.1	7.0	5.1	4.8	3.8	32
34	12.0	7.4	10.0	5.9	6.8	4.9	4.6	3.7	34
36	12.0	7.2	9.8	5.7	6.7	4.7	4.4	3.6	36
38	12.0	7.1	9.7	5.6	6.6	4.6	4.3	3.5	38
40	11.8	6.9	9.5	5.4	6.4	4.5	4.2	3.4	40
42	11.4	6.8	9.1	5.3	6.2	4.3	4.1	3.3	42
44	10.9	6.7	8.7	5.2	6.1	4.2	4.0	3.2	44
46	45.4m x	6.7	8.3	5.1	6.0	4.1	3.8	3.2	46
48	10.3t	46.2m x	8.0	5.0	5.9	4.0	3.8	3.1	48
50		6.6t	7.7	4.9	5.8	3.9	3.6	3.0	50
52			51.1m x	4.9	5.7	3.9	3.6	3.0	52
54			7.5t	52.2m x	5.6	3.8	3.5	3.0	54
56				4.9t	5.5	3.8	3.4	3.0	56
58					56.7m x	3.7	3.3	2.9	58
60					5.4t	58.2m x	3.2	2.9	60
62						3.7t	3.2	2.9	62
64							62.4m x	2.9	64
66							3.1t	64.2m x	66
68								2.8t	68

* For notes about the table above, refer to page 24.

■ Crane Jib



Unit: ton

Boom Length (m)	39								Boom Length (m)
Jib Length (m)	13		19		25		31		Jib Length (m)
Offset Angle (°)	10	30	10	30	10	30	10	30	Offset Angle (°)
Working Radius (m)	10	30	10	30	10	30	10	30	Working Radius (m)
10	13.0m x								10
12	12.0t		15.0m x						12
14	12.0	16.9m x	11.9t		17.1m x				14
16	12.0	10.1t	11.8		8.3t		19.1m x		16
18	12.0	9.9	11.7	20.8m x	8.3		5.8t		18
20	12.0	9.5	11.5	7.5t	8.1		5.7		20
22	12.0	9.1	11.3	7.4	8.0	24.6m x	5.6		22
24	12.0	8.8	11.1	7.1	7.8	5.9t	5.4		24
26	12.0	8.5	10.9	6.8	7.6	5.8	5.3	28.5m x	26
28	12.0	8.2	10.7	6.6	7.5	5.5	5.1	3.9t	28
30	12.0	8.0	10.5	6.4	7.3	5.3	5.0	3.9	30
32	12.0	7.8	10.4	6.2	7.1	5.1	4.8	3.8	32
34	12.0	7.6	10.2	6.0	7.0	5.0	4.7	3.7	34
36	12.0	7.4	10.0	5.8	6.8	4.8	4.6	3.6	36
38	12.0	7.2	9.8	5.7	6.6	4.7	4.4	3.5	38
40	12.0	7.1	9.7	5.5	6.5	4.5	4.3	3.4	40
42	11.5	6.9	9.5	5.4	6.4	4.4	4.2	3.4	42
44	10.7	6.8	9.1	5.3	6.3	4.3	4.0	3.3	44
46	10.0	6.7	8.7	5.2	6.1	4.2	3.9	3.2	46
48	9.3	6.7	8.4	5.1	6.0	4.1	3.8	3.1	48
50		48.8m x	8.1	5.0	5.9	4.0	3.7	3.1	50
52		6.6t	7.8	4.9	5.8	3.9	3.7	3.0	52
54			53.7m x	4.9	5.7	3.9	3.5	3.0	54
56			7.5t	54.8m x	5.6	3.8	3.5	3.0	56
58				4.8t	5.5	3.8	3.4	2.9	58
60					59.3m x	3.7	3.3	2.9	60
62					5.3t	60.8m x	3.3	2.9	62
64						3.7t	3.2	2.9	64
66							65.0m x	2.9	66
68							3.1t	66.8m x	68
70								2.8t	70

Unit: ton

Boom Length (m)	42								Boom Length (m)
Jib Length (m)	13		19		25		31		Jib Length (m)
Offset Angle (°)	10	30	10	30	10	30	10	30	Offset Angle (°)
Working Radius (m)	10	30	10	30	10	30	10	30	Working Radius (m)
13.5	12.0		15.6m x						13.5
14	12.0		11.9t		17.6m x				14
16	12.0	10.0	11.9		8.3t		19.7m x		16
18	12.0	10.0	11.7	21.3m x	8.3		5.8t		18
20	12.0	9.6	11.6	7.5t	8.2		5.8		20
22	12.0	9.2	11.4	7.5	8.0	25.1m x	5.6		22
24	12.0	8.9	11.2	7.2	7.8	5.9t	5.5		24
26	12.0	8.6	10.9	6.9	7.7	5.8	5.3	29.0m x	26
28	12.0	8.4	10.8	6.7	7.5	5.6	5.2	3.9t	28
30	12.0	8.1	10.6	6.5	7.3	5.4	5.0	3.9	30
32	12.0	7.9	10.4	6.3	7.2	5.2	4.9	3.8	32
34	12.0	7.7	10.3	6.1	7.0	5.0	4.7	3.7	34
36	12.0	7.5	10.1	5.9	6.9	4.9	4.6	3.6	36
38	12.0	7.3	10.0	5.8	6.7	4.7	4.5	3.5	38
40	12.0	7.2	9.8	5.6	6.6	4.6	4.3	3.5	40
42	11.4	7.1	9.6	5.5	6.5	4.5	4.2	3.4	42
44	10.6	6.9	9.5	5.4	6.4	4.4	4.2	3.3	44
46	9.9	6.8	9.1	5.3	6.2	4.3	4.0	3.2	46
48	9.2	6.8	8.7	5.2	6.1	4.2	3.9	3.2	48
50	8.6	6.7	8.4	5.1	6.0	4.1	3.8	3.1	50
52	50.6m x	51.4m x	8.1	5.0	5.9	4.0	3.7	3.1	52
54	8.4t	6.6t	7.8	4.9	5.8	3.9	3.6	3.0	54
56			7.4	4.9	5.7	3.9	3.6	3.0	56
58			56.3m x	57.4m x	5.6	3.8	3.5	2.9	58
60			7.3t	4.8t	5.5	3.8	3.4	2.9	60
62					61.9m x	3.7	3.3	2.9	62
64					5.3t	63.4m x	3.3	2.9	64
66						3.7t	3.2	2.9	66
68							67.6m x	2.9	68
70							3.1t	69.4m x	70
72								2.8t	72

* For notes about the table above, refer to page 24.

Crane Jib



Unit: ton

Boom Length (m)	45								Boom Length (m)
Jib Length (m)	13		19		25		31		Jib Length (m)
Offset Angle (°)	10	30	10	30	10	30	10	30	Offset Angle (°)
Working Radius (m)	10	30	10	30	10	30	10	30	Working Radius (m)
14	12.0	17.9m x	16.1m x						14
16	12.0	10.0t	11.8t		18.1m x				16
18	12.0	10.1	11.7	21.8m x	8.4t		20.2m x		18
20	12.0	9.7	11.6	7.5t	8.2		5.7t		20
22	12.0	9.4	11.5	7.5	8.1	25.7m x	5.7		22
24	12.0	9.0	11.3	7.3	7.9	5.8t	5.5		24
26	12.0	8.8	11.1	7.0	7.7	5.9	5.4	29.5m x	26
28	12.0	8.5	10.9	6.8	7.6	5.6	5.2	3.9t	28
30	12.0	8.3	10.7	6.6	7.4	5.5	5.1	3.9	30
32	12.0	8.0	10.5	6.4	7.3	5.3	4.9	3.8	32
34	12.0	7.8	10.3	6.2	7.1	5.1	4.8	3.7	34
36	12.0	7.6	10.2	6.0	7.0	5.0	4.7	3.6	36
38	12.0	7.5	10.0	5.9	6.8	4.8	4.5	3.6	38
40	12.0	7.3	9.9	5.7	6.7	4.7	4.4	3.5	40
42	11.2	7.2	9.8	5.6	6.5	4.5	4.3	3.4	42
44	10.4	7.0	9.7	5.4	6.4	4.4	4.2	3.3	44
46	9.7	6.9	9.5	5.3	6.3	4.3	4.1	3.3	46
48	9.0	6.8	9.1	5.2	6.2	4.2	4.0	3.2	48
50	8.4	6.8	8.7	5.1	6.1	4.1	3.9	3.1	50
52	7.9	6.7	8.1	5.1	6.0	4.1	3.8	3.1	52
54	53.2m x	6.6	7.6	5.0	5.9	4.0	3.7	3.0	54
56	7.5t		7.2	4.9	5.8	3.9	3.6	3.0	56
58			6.7	4.9	5.7	3.8	3.5	3.0	58
60			58.9m x	4.8	5.7	3.8	3.5	2.9	60
62			6.5t		5.6	3.8	3.4	2.9	62
64					5.4	3.7	3.3	2.9	64
66					64.5m x	3.7	3.3	2.9	66
68					5.3t		3.2	2.9	68
70							3.2	2.9	70
72							70.2m x	2.8	72
74							3.1t		74

Boom Length (m)	48								Boom Length (m)
Jib Length (m)	13		19		25		31		Jib Length (m)
Offset Angle (°)	10	30	10	30	10	30	10	30	Offset Angle (°)
Working Radius (m)	10	30	10	30	10	30	10	30	Working Radius (m)
12	14.6m x								12
14	12.0t		16.6m x						14
16	12.0	18.5m x	11.9t		18.7m x				16
18	12.0	10.0t	11.8		8.3t		20.7m x		18
20	12.0	9.8	11.7	22.3m x	8.3		5.7t		20
22	12.0	9.5	11.5	7.5t	8.1		5.7		22
24	12.0	9.2	11.4	7.3	8.0	26.2m x	5.5		24
26	12.0	8.9	11.2	7.1	7.8	5.8t	5.4		26
28	12.0	8.6	11.0	6.8	7.7	5.7	5.3		28
30	12.0	8.4	10.8	6.6	7.5	5.5	5.1	3.9	30
32	12.0	8.2	10.7	6.4	7.4	5.3	5.0	3.8	32
34	12.0	8.0	10.5	6.3	7.2	5.2	4.9	3.8	34
36	12.0	7.8	10.2	6.1	7.1	5.0	4.8	3.7	36
38	12.0	7.6	10.1	5.9	6.9	4.9	4.6	3.6	38
40	11.9	7.4	10.0	5.8	6.8	4.7	4.5	3.5	40
42	11.0	7.3	9.9	5.7	6.7	4.6	4.4	3.4	42
44	10.2	7.2	9.7	5.5	6.6	4.5	4.3	3.4	44
46	9.5	7.0	9.6	5.4	6.4	4.4	4.2	3.3	46
48	8.8	6.9	9.1	5.3	6.3	4.3	4.1	3.2	48
50	8.2	6.8	8.5	5.2	6.2	4.2	4.0	3.2	50
52	7.6	6.8	7.9	5.1	6.1	4.1	3.9	3.1	52
54	7.1	6.7	7.4	5.1	6.0	4.0	3.8	3.1	54
56	55.8m x	6.7	7.0	5.0	5.9	4.0	3.7	3.0	56
58	6.7t	56.6m x	6.5	4.9	5.8	3.9	3.6	3.0	58
60		6.6t	6.1	4.9	5.7	3.8	3.5	3.0	60
62			61.5m x	4.9	5.6	3.8	3.5	3.0	62
64			5.8t	4.8t	5.6	3.8	3.4	2.9	64
66					5.3	3.7	3.3	2.9	66
68					67.1m x	3.7	3.3	2.9	68
70					5.0t	68.6m x	3.2	2.9	70
72						3.7t	3.2	2.9	72
74							72.8m x	2.9	74
76							3.1t	74.6m x	76
78								2.8t	78

* For notes about the table above, refer to page 24.

■ Crane Jib



Unit: ton

Boom Length (m)	51								Boom Length (m)
Jib Length (m)	13		19		25		31		Jib Length (m)
Offset Angle (°)	10	30	10	30	10	30	10	30	Offset Angle (°)
Working Radius (m)									Working Radius (m)
12	15.1m x								12
14	12.0t		17.1m x						14
16	12.0	19.0m x	11.9t		19.2m x				16
18	12.0	10.0t	11.9		8.3t		21.2m x		18
20	12.0	9.9	11.7	22.8m x	8.3		5.7t		20
22	12.0	9.5	11.6	7.5t	8.1		5.7		22
24	12.0	9.3	11.4	7.4	8.0	26.7m x	5.6		24
26	12.0	9.0	11.2	7.1	7.8	5.8t	5.5		26
28	12.0	8.7	11.0	6.9	7.7	5.7	5.3	30.6m x	28
30	12.0	8.5	10.9	6.7	7.5	5.6	5.2	3.9t	30
32	12.0	8.3	10.7	6.5	7.4	5.4	5.0	3.8	32
34	12.0	8.1	10.6	6.3	7.3	5.2	4.9	3.8	34
36	12.0	7.9	10.4	6.2	7.1	5.1	4.8	3.7	36
38	12.0	7.7	10.3	6.0	7.0	4.9	4.7	3.6	38
40	11.7	7.5	10.2	5.9	6.9	4.8	4.6	3.5	40
42	10.8	7.4	9.9	5.7	6.8	4.7	4.5	3.5	42
44	10.0	7.3	9.8	5.6	6.6	4.6	4.4	3.4	44
46	9.3	7.1	9.6	5.5	6.5	4.5	4.3	3.3	46
48	8.6	7.0	9.0	5.4	6.4	4.4	4.1	3.3	48
50	8.0	6.9	8.4	5.3	6.3	4.3	4.0	3.2	50
52	7.5	6.8	7.8	5.2	6.2	4.2	3.9	3.2	52
54	7.0	6.8	7.3	5.1	6.1	4.1	3.8	3.1	54
56	6.5	6.6	6.8	5.1	6.0	4.0	3.8	3.1	56
58	6.1	6.2	6.4	5.0	5.9	4.0	3.7	3.0	58
60	58.4m x	59.2m x	5.9	4.9	5.9	3.9	3.6	3.0	60
62	5.9t	5.8t	5.6	4.9	5.7	3.8	3.5	2.9	62
64			5.2	4.9	5.4	3.8	3.5	2.9	64
66			64.1m x	65.2m x	5.1	3.8	3.4	2.9	66
68			5.1t	4.8t	4.8	3.7	3.4	2.9	68
70					69.7m x	3.7	3.3	2.9	70
72					4.5t	71.2m x	3.2	2.9	72
74						3.7t	3.2	2.9	74
76							75.4m x	2.9	76
78							3.1t	77.2m x	78
80								2.8t	80

* For notes about the table above, refer to page 24.

■ Crane Jib



Unit: ton

Boom Length (m)	54								Boom Length (m)
Jib Length (m)	13		19		25		31		Jib Length (m)
Offset Angle (°)	10	30	10	30	10	30	10	30	Offset Angle (°)
Working Radius (m)									Working Radius (m)
12	15.6m x								12
14	12.0t		17.6m x						14
16	12.0	19.5m x	11.8t		19.7m x				16
18	12.0	10.0t	11.9		8.3t		21.8m x		18
20	12.0	9.9	11.7	23.4m x	8.3		5.7t		20
22	12.0	9.6	11.6	7.5t	8.2		5.7		22
24	12.0	9.3	11.4	7.4	8.0	27.2m x	5.6		24
26	12.0	9.1	11.3	7.2	7.9	5.8t	5.5		26
28	12.0	8.8	11.1	7.0	7.8	5.8	5.4	31.1m x	28
30	12.0	8.6	10.9	6.8	7.6	5.6	5.2	3.8t	30
32	12.0	8.4	10.8	6.6	7.5	5.4	5.1	3.9	32
34	12.0	8.2	10.6	6.4	7.3	5.3	5.0	3.8	34
36	12.0	8.0	10.5	6.3	7.2	5.1	4.9	3.7	36
38	12.0	7.8	10.3	6.1	7.1	5.0	4.7	3.6	38
40	11.5	7.7	10.2	6.0	7.0	4.9	4.6	3.6	40
42	10.6	7.5	10.1	5.8	6.8	4.7	4.5	3.5	42
44	9.8	7.4	10.0	5.7	6.7	4.6	4.4	3.4	44
46	9.1	7.2	9.4	5.6	6.6	4.5	4.3	3.4	46
48	8.4	7.1	8.7	5.5	6.5	4.4	4.2	3.3	48
50	7.8	7.0	8.1	5.4	6.4	4.3	4.1	3.2	50
52	7.2	6.9	7.5	5.3	6.3	4.2	4.0	3.2	52
54	6.7	6.8	7.0	5.2	6.2	4.1	3.9	3.1	54
56	6.3	6.4	6.6	5.1	6.1	4.1	3.8	3.1	56
58	5.8	5.9	6.1	5.0	6.0	4.0	3.7	3.1	58
60	5.4	5.5	5.7	5.0	5.9	3.9	3.7	3.0	60
62	61.0m x	61.8m x	5.3	4.9	5.6	3.9	3.6	3.0	62
64	5.2t	5.1t	5.0	4.9	5.2	3.8	3.5	2.9	64
66			4.6	4.7	4.9	3.8	3.5	2.9	66
68			66.7m x	67.8m x	4.5	3.8	3.4	2.9	68
70			4.5t	4.4t	4.2	3.7	3.3	2.9	70
72					4.0	3.7	3.3	2.9	72
74					72.3m x	73.8m x	3.2	2.9	74
76					3.9t	3.7t	3.2	2.9	76
78							3.1	2.9	78
80								79.8m x	80
82								2.8t	82

* For notes about the table above, refer to page 24.

■ Crane Jib



Unit: ton

Boom Length (m)	57								Boom Length (m)
Jib Length (m)	13		19		25		31		Jib Length (m)
Offset Angle (°)	10	30	10	30	10	30	10	30	Offset Angle (°)
Working Radius (m)	10	30	10	30	10	30	10	30	Working Radius (m)
16.1	12.0		18.2m x						16.1
18	12.0		11.8t		20.2m x				18
20	12.0	10.0	11.7	23.9m x	8.3t		22.3m x		20
22	12.0	9.7	11.6	7.4t	8.3		5.7t		22
24	12.0	9.4	11.5	7.5	8.1	27.7m x	5.6		24
26	12.0	9.2	11.4	7.3	8.0	5.8t	5.5		26
28	12.0	8.9	11.2	7.0	7.8	5.8	5.4	31.6m x	28
30	12.0	8.7	11.1	6.8	7.7	5.6	5.3	3.9t	30
32	12.0	8.5	10.9	6.7	7.5	5.5	5.2	3.9	32
34	12.0	8.3	10.7	6.5	7.4	5.3	5.0	3.8	34
36	12.0	8.1	10.6	6.3	7.3	5.2	4.9	3.8	36
38	12.0	7.9	10.4	6.2	7.1	5.0	4.8	3.7	38
40	11.3	7.8	10.3	6.0	7.0	4.9	4.7	3.6	40
42	10.4	7.6	10.1	5.9	6.9	4.8	4.6	3.5	42
44	9.6	7.5	9.9	5.8	6.8	4.7	4.5	3.4	44
46	8.9	7.3	9.2	5.7	6.7	4.6	4.4	3.4	46
48	8.2	7.2	8.5	5.5	6.5	4.5	4.3	3.3	48
50	7.6	7.1	7.9	5.4	6.4	4.4	4.2	3.3	50
52	7.0	7.0	7.3	5.3	6.3	4.3	4.1	3.2	52
54	6.5	6.7	6.8	5.3	6.3	4.2	4.0	3.2	54
56	6.0	6.2	6.3	5.2	6.2	4.1	3.9	3.1	56
58	5.6	5.8	5.9	5.1	6.1	4.1	3.8	3.1	58
60	5.2	5.3	5.5	5.0	5.7	4.0	3.8	3.0	60
62	4.8	4.9	5.1	5.0	5.4	3.9	3.7	3.0	62
64	63.6m x	4.6	4.8	4.9	5.0	3.9	3.6	3.0	64
66	4.5t	64.4m x	4.4	4.6	4.7	3.8	3.5	2.9	66
68		4.4t	4.1	4.2	4.3	3.8	3.5	2.9	68
70			69.3m x	3.9	4.0	3.7	3.4	2.9	70
72			3.9t	70.4m x	3.8	3.7	3.3	2.9	72
74				3.8t	3.5	3.6	3.3	2.9	74
76					74.9m x	3.4	3.2	2.9	76
78					3.3t	76.4m x	3.2	2.9	78
80						3.3t	3.0	2.9	80
82							80.5m x	2.9	82
84							2.9t	82.4m x	84
86								2.8t	86

* For notes about the table above, refer to page 24.

■ Crane Jib



Unit: ton

Boom Length (m)	60								Boom Length (m)
Jib Length (m)	13		19		25		31		Jib Length (m)
Offset Angle (°)	10	30	10	30	10	30	10	30	Offset Angle (°)
Working Radius (m)									Working Radius (m)
16	16.6m x 12.0t		18.7m x 11.8t						16
18	12.0	20.5m x 9.9t	11.8		20.7m x 8.3t		22.8m x 5.7t		18
20	12.0	9.9t	11.8		8.3t		5.7t		20
22	12.0	9.8	11.7	24.4m x 7.4t	8.2		5.7t		22
24	12.0	9.5	11.5	7.4t	8.1		5.7		24
26	12.0	9.2	11.4	7.3	8.0	28.3m x 5.8t	5.5		26
28	12.0	9.0	11.2	7.1	7.8	5.8t	5.4		28
30	12.0	8.8	11.1	6.9	7.7	5.7	5.3	32.1m x 3.8t	30
32	12.0	8.6	11.0	6.7	7.6	5.5	5.2	3.8t	32
34	12.0	8.4	10.8	6.6	7.5	5.4	5.1	3.8	34
36	12.0	8.2	10.7	6.4	7.3	5.2	5.0	3.7	36
38	12.0	8.0	10.6	6.2	7.2	5.1	4.8	3.7	38
40	11.1	7.8	10.4	6.1	7.1	5.0	4.7	3.6	40
42	10.2	7.7	10.2	6.0	7.0	4.8	4.6	3.5	42
44	9.4	7.6	9.7	5.8	6.8	4.7	4.5	3.5	44
46	8.6	7.4	9.0	5.7	6.7	4.6	4.4	3.4	46
48	8.0	7.3	8.3	5.6	6.6	4.5	4.3	3.4	48
50	7.4	7.2	7.7	5.5	6.5	4.4	4.2	3.3	50
52	6.8	7.1	7.1	5.4	6.4	4.3	4.1	3.2	52
54	6.3	6.5	6.6	5.3	6.3	4.3	4.0	3.2	54
56	5.8	6.0	6.1	5.2	6.2	4.2	4.0	3.1	56
58	5.4	5.6	5.7	5.2	5.9	4.1	3.9	3.1	58
60	5.0	5.1	5.3	5.1	5.5	4.0	3.8	3.1	60
62	4.6	4.7	4.9	5.0	5.1	4.0	3.7	3.0	62
64	4.3	4.4	4.5	4.8	4.8	3.9	3.7	3.0	64
66	3.9	4.0	4.2	4.4	4.4	3.9	3.6	3.0	66
68	66.2m x 3.9t	67.0m x 3.8t	3.9	4.1	4.1	3.8	3.5	2.9	68
70			3.6	3.7	3.8	3.8	3.5	2.9	70
72			71.9m x 3.3t	3.4	3.5	3.7	3.4	2.9	72
74			3.3t	73.0m x 3.2t	3.3	3.5	3.3	2.9	74
76					3.0	3.2	3.2	2.9	76
78					77.5m x 2.8t	2.9	3.0	2.9	78
80						79.0m x 2.7t	2.8	2.9	80
82							2.5	2.7	82
84							83.1m x 2.4t	2.5	84
86								85.0m x 2.3t	86
88								2.3t	88

* For notes about the table above, refer to page 24.

■ Crane Jib



Unit: ton

Boom Length (m)	63								Boom Length (m)
Jib Length (m)	13		19		25		31		Jib Length (m)
Offset Angle (°)	10	30	10	30	10	30	10	30	Offset Angle (°)
Working Radius (m)									Working Radius (m)
16	17.2m x		19.2m x						16
18	12.0t		11.8t		21.3m x				18
20	12.0	21.1m x	11.8		8.3t		23.3m x		20
22	12.0	9.9t	11.7				5.7t		22
24	12.0	9.8	11.6	24.9m x	8.3		5.7		24
26	12.0	9.6	11.5	7.4t	8.1		5.6		26
28	12.0	9.3	11.3	7.4	8.0	28.8m x	5.6		28
30	12.0	9.1	11.3	7.2	7.9	5.8t	5.5		30
32	12.0	8.9	11.1	7.0	7.7	5.7	5.4	32.6m x	32
34	12.0	8.7	11.0	6.8	7.6	5.6	5.2	3.8t	34
36	12.0	8.5	10.8	6.6	7.5	5.4	5.1	3.8	36
38	12.0	8.3	10.7	6.5	7.4	5.3	5.0	3.8	38
40	11.9	8.1	10.6	6.3	7.3	5.1	4.9	3.7	40
42	10.9	7.9	10.4	6.2	7.2	5.0	4.8	3.6	42
44	10.0	7.8	10.4	6.0	7.0	4.9	4.7	3.5	44
46	9.2	7.6	9.6	5.9	6.9	4.8	4.6	3.5	46
48	8.5	7.5	8.8	5.8	6.8	4.7	4.5	3.4	48
50	7.8	7.4	8.2	5.7	6.7	4.6	4.4	3.4	50
52	7.2	7.3	7.5	5.6	6.6	4.5	4.3	3.3	52
54	6.6	6.9	7.0	5.5	6.5	4.4	4.2	3.3	54
56	6.1	6.4	6.4	5.4	6.4	4.3	4.1	3.2	56
58	5.7	5.9	6.0	5.3	6.2	4.2	4.0	3.2	58
60	5.2	5.4	5.5	5.2	5.8	4.2	3.9	3.1	60
62	4.8	5.0	5.1	5.2	5.4	4.1	3.9	3.1	62
64	4.4	4.6	4.7	5.0	5.0	4.0	3.8	3.1	64
66	4.1	4.2	4.4	4.6	4.6	4.0	3.7	3.0	66
68	3.7	3.8	4.0	4.3	4.3	3.9	3.7	3.0	68
70	3.4	3.5	3.7	3.9	3.9	3.9	3.6	2.9	70
72	68.8m x	69.6m x	3.4	3.6	3.6	3.8	3.5	2.9	72
74	3.3t	3.2t	3.1	3.3	3.4	3.6	3.5	2.9	74
76			2.9	3.0	3.1	3.3	3.3	2.9	76
78			74.5m x	75.6m x	2.8	3.0	3.0	2.9	78
80			2.8t	2.7t	2.6	2.8	2.8	2.8	80
82					2.4	2.5	2.6	2.8	82
84					80.1m x	81.6m x	2.4	2.6	84
86					2.3t	2.3t	2.2	2.3	86
88							85.7m x	2.1	88
90							1.9t	87.6m x	90
								1.9t	

* For notes about the table above, refer to page 24.

■ Crane Jib



Unit: ton

Boom Length (m)	66								Boom Length (m)
Jib Length (m)	13		19		25		31		Jib Length (m)
Offset Angle (°)	10	30	10	30	10	30	10	30	Offset Angle (°)
Working Radius (m)									Working Radius (m)
16	17.7m x 12.0t		19.7m x 11.8t						16
18	12.0	21.6m x 9.9t	11.8		21.8m x 8.3t		23.8m x 5.7t		18
20	12.0	9.9t	11.8		8.3t		5.7t		20
22	12.0	9.9	11.7	25.4m x 7.4t	8.4		5.7		22
24	12.0	9.6	11.6	7.4t	8.2		5.7		24
26	12.0	9.4	11.5	7.4	8.1	29.3m x 5.8t	5.6		26
28	12.0	9.2	11.4	7.2	7.9	5.8t	5.5		28
30	12.0	8.9	11.3	7.0	7.8	5.8	5.4	33.2m x 3.9t	30
32	12.0	8.7	11.1	6.8	7.7	5.6	5.3	3.9t	32
34	12.0	8.5	10.9	6.7	7.6	5.5	5.2	3.9	34
36	12.0	8.4	10.8	6.5	7.4	5.3	5.1	3.8	36
38	11.7	8.2	10.6	6.4	7.3	5.2	4.9	3.7	38
40	10.7	8.0	10.5	6.2	7.2	5.1	4.8	3.6	40
42	9.8	7.9	10.2	6.1	7.1	4.9	4.7	3.6	42
44	9.0	7.7	9.4	6.0	7.0	4.8	4.6	3.5	44
46	8.3	7.6	8.6	5.9	6.9	4.7	4.5	3.4	46
48	7.6	7.5	8.0	5.7	6.8	4.6	4.4	3.4	48
50	7.0	7.3	7.3	5.6	6.6	4.5	4.3	3.3	50
52	6.4	6.8	6.8	5.5	6.6	4.4	4.2	3.3	52
54	5.9	6.2	6.3	5.5	6.5	4.4	4.2	3.3	54
56	5.4	5.7	5.8	5.4	6.0	4.3	4.1	3.2	56
58	5.0	5.2	5.3	5.3	5.6	4.2	4.0	3.1	58
60	4.6	4.8	4.9	5.2	5.2	4.1	3.9	3.1	60
62	4.2	4.4	4.5	4.8	4.8	4.1	3.8	3.1	62
64	3.9	4.0	4.2	4.4	4.4	4.0	3.8	3.0	64
66	3.5	3.7	3.8	4.1	4.1	4.0	3.7	3.0	66
68	3.2	3.3	3.5	3.7	3.7	3.9	3.6	3.0	68
70	2.9	3.0	3.2	3.4	3.4	3.8	3.6	2.9	70
72	71.4m x 2.7t	2.7	2.9	3.1	3.2	3.5	3.4	2.9	72
74	2.7t	72.2m x 2.6t	2.7	2.8	2.9	3.2	3.1	2.9	74
76		2.6t	2.4	2.5	2.6	2.9	2.8	2.9	76
78			77.1m x 2.2t	2.3	2.4	2.6	2.6	2.9	78
80			2.2t	78.2m x 2.2t	2.2	2.4	2.4	2.7	80
82				2.2t	2.0	2.1	2.2	2.4	82
84					82.6m x 1.9t	83.7m x 1.9t	2.0	2.2	84
86					1.9t	1.9t	84.4m x 1.9t	2.0	86
88							1.9t	86.4m x 1.9t	88
90								1.9t	90

* For notes about the table above, refer to page 24.

■ Crane Jib



Unit: ton

Boom Length (m)	69								Boom Length (m)
Jib Length (m)	13		19		25		31		Jib Length (m)
Offset Angle (°)	10	30	10	30	10	30	10	30	Offset Angle (°)
Working Radius (m)	10	30	10	30	10	30	10	30	Working Radius (m)
18.2	12.0		20.3m x						18.2
20	12.0		11.8t		22.3m x				20
22	12.0	9.9	11.7		8.3t		24.4m x		22
24	12.0	9.7	11.6		8.2		5.6t		24
26	12.0	9.5	11.5	7.4	8.1	29.8m x	5.6		26
28	12.0	9.2	11.4	7.3	8.0	5.8t	5.5		28
30	12.0	9.0	11.3	7.1	7.9	5.8	5.4	33.7m x	30
32	12.0	8.8	11.2	6.9	7.8	5.6	5.3	3.8t	32
34	12.0	8.6	11.0	6.7	7.6	5.5	5.2	3.9	34
36	12.0	8.4	10.9	6.6	7.5	5.4	5.1	3.8	36
38	11.5	8.3	10.8	6.4	7.4	5.2	5.0	3.7	38
40	10.5	8.1	10.6	6.3	7.3	5.1	4.9	3.7	40
42	9.6	8.0	10.0	6.2	7.2	5.0	4.8	3.6	42
44	8.8	7.8	9.2	6.0	7.0	4.9	4.7	3.5	44
46	8.1	7.7	8.4	5.9	6.9	4.8	4.6	3.5	46
48	7.4	7.6	7.8	5.8	6.8	4.7	4.5	3.4	48
50	6.8	7.2	7.1	5.7	6.7	4.6	4.4	3.4	50
52	6.2	6.6	6.6	5.6	6.6	4.5	4.3	3.3	52
54	5.7	6.0	6.0	5.5	6.3	4.4	4.2	3.3	54
56	5.2	5.5	5.6	5.4	5.8	4.3	4.1	3.2	56
58	4.8	5.0	5.1	5.3	5.4	4.3	4.0	3.2	58
60	4.4	4.6	4.7	5.1	5.0	4.2	4.0	3.1	60
62	4.0	4.2	4.3	4.7	4.6	4.1	3.9	3.1	62
64	3.6	3.8	3.9	4.3	4.2	4.1	3.9	3.0	64
66	3.3	3.5	3.6	3.9	3.9	4.0	3.8	3.0	66
68	3.0	3.1	3.3	3.6	3.5	3.9	3.7	3.0	68
70	2.7	2.8	3.0	3.2	3.2	3.6	3.4	3.0	70
72	2.4	2.5	2.7	2.9	3.0	3.3	3.2	2.9	72
74	2.1	2.3	2.5	2.6	2.7	3.0	2.9	2.9	74
76		74.8m x	2.2	2.4	2.4	2.7	2.6	2.9	76
78		2.1t	2.0	2.1	2.2	2.4	2.4	2.8	78
80			78.5m x	79.5m x	2.0	2.2	2.2	2.5	80
82			1.9t	1.9t	80.6m x	1.9	1.9	2.3	82
84					1.90t	82.3m x	82.4m x	2.0	84
86						1.9t	1.9t	84.9m x	86
88								1.9t	88

* For notes about the table above, refer to page 24.

■ Crane Jib



Unit: ton

Boom Length (m)	72								Boom Length (m)
Jib Length (m)	13		19		25		31		Jib Length (m)
Offset Angle (°)	10	30	10	30	10	30	10	30	Offset Angle (°)
Working Radius (m)									Working Radius (m)
18	18.7m x								18
20	12.0t		20.8m x						20
22	12.0	22.6m x	11.8t		22.8m x				22
24	12.0	9.9t	11.8		8.2t		24.9m x		24
26	12.0	9.8	11.7	26.5m x	8.2		5.6t		26
28	12.0	9.5	11.6	7.4t	8.1		5.6		28
30	12.0	9.3	11.4	7.3	8.0	30.3m x	5.5		30
32	12.0	9.1	11.3	7.1	7.9	5.7t	5.4		32
34	12.0	8.9	11.2	6.9	7.7	5.7	5.3	34.2m x	34
36	12.0	8.7	11.0	6.8	7.6	5.5	5.2	3.8t	36
38	12.0	8.5	10.9	6.6	7.5	5.4	5.1	3.8	38
40	11.3	8.4	10.8	6.5	7.4	5.3	5.0	3.7	40
42	10.3	8.2	10.7	6.3	7.3	5.1	4.9	3.7	42
44	9.4	8.0	9.8	6.2	7.2	5.0	4.8	3.6	44
46	8.6	7.9	8.9	6.1	7.1	4.9	4.7	3.5	46
48	7.8	7.8	8.2	6.0	7.0	4.8	4.6	3.5	48
50	7.2	7.6	7.5	5.9	6.9	4.7	4.5	3.4	50
52	6.5	6.9	6.9	5.8	6.8	4.6	4.5	3.4	52
54	6.0	6.3	6.3	5.7	6.6	4.5	4.4	3.3	54
56	5.5	5.8	5.8	5.6	6.1	4.4	4.3	3.3	56
58	5.0	5.3	5.3	5.5	5.6	4.4	4.2	3.2	58
60	4.5	4.8	4.9	5.3	5.1	4.3	4.1	3.2	60
62	4.1	4.4	4.4	4.9	4.7	4.2	4.0	3.1	62
64	3.7	4.0	4.1	4.4	4.3	4.2	3.9	3.1	64
66	3.4	3.6	3.7	4.1	4.0	4.1	3.9	3.1	66
68	3.1	3.2	3.4	3.7	3.6	4.0	3.8	3.0	68
70	2.7	2.9	3.0	3.3	3.3	3.7	3.5	3.0	70
72	2.5	2.6	2.7	3.0	3.0	3.4	3.2	3.0	72
74	2.2	2.3	2.5	2.7	2.7	3.1	2.9	2.9	74
76	1.9	2.0	2.2	2.4	2.4	2.8	2.7	2.9	76
78	74.1m x	74.8m x	2.0	2.1	2.2	2.5	2.4	2.8	78
80	1.9t	1.9t	76.4m x	77.7m x	2.0	2.2	2.2	2.6	80
82			1.9t	1.9t	78.4m x	2.0	1.9	2.3	82
84					1.9t	80.5m x	80.1m x	2.0	84
86						1.9t	1.9t	83.2m x	86
								1.9t	

* For notes about the table above, refer to page 24.

■ Main Boom with Crane Jib



Unit: ton

Boom Length (m)	24								Boom Length (m)
Jib Length (m)	13		19		25		31		Jib Length (m)
Offset Angle (°)	10	30	10	30	10	30	10	30	Offset Angle (°)
Working Radius (m)	10	30	10	30	10	30	10	30	Working Radius (m)
6.1	120.0	120.0	120.0	119.5	119.7	118.5	119.0	117.5	6.1
7	105.4	105.0	104.9	104.2	104.3	103.3	103.6	102.3	7
8	92.2	91.8	91.7	91.1	91.1	90.3	90.4	89.3	8
9	81.8	81.5	81.3	80.8	80.7	80.0	80.0	79.1	9
10	73.3	73.1	72.8	72.4	72.3	71.6	71.6	70.8	10
12	60.6	60.4	60.1	59.7	59.5	59.0	58.9	58.2	12
14	50.6	50.3	50.0	49.6	49.3	48.8	48.5	47.8	14
16	42.0	41.8	41.4	41.1	40.7	40.3	40.0	39.5	16
18	35.6	35.5	35.1	34.9	34.4	34.2	33.7	33.4	18
20	30.8	30.7	30.3	30.1	29.6	29.5	28.9	28.7	20
22	26.2	26.2	25.7	25.7	25.1	25.1	24.5	24.4	22
24	22.3m x	22.3m x	22.3m x	22.3m x	22.3m x	22.3m x	22.3m x	22.3m x	24
26	25.2t	25.1t	24.6t	24.6t	24.0t	24.0t	23.4t	23.3t	26

Unit: ton

Boom Length (m)	27								Boom Length (m)
Jib Length (m)	13		19		25		31		Jib Length (m)
Offset Angle (°)	10	30	10	30	10	30	10	30	Offset Angle (°)
Working Radius (m)	10	30	10	30	10	30	10	30	Working Radius (m)
6	6.6m x	6.6m x	6.6m x	6.6m x	6.6m x	6.6m x	6.6m x	6.6m x	6
7	108.0t	108.0t	108.0t	108.0t	108.0t	108.0t	108.0t	108.0t	7
8	105.2	104.8	104.7	104.0	104.1	103.2	103.5	102.2	8
9	92.0	91.6	91.5	90.9	90.9	90.1	90.3	89.2	9
10	81.6	81.3	81.1	80.6	80.5	79.8	79.9	78.9	10
12	73.2	72.9	72.7	72.2	72.1	71.5	71.5	70.6	12
14	60.4	60.2	59.9	59.6	59.4	58.9	58.8	58.1	14
16	50.5	50.2	49.9	49.5	49.2	48.7	48.5	47.8	16
18	41.9	41.7	41.3	41.0	40.7	40.3	39.9	39.4	18
20	35.5	35.4	35.0	34.8	34.4	34.1	33.7	33.3	20
22	30.7	30.6	30.2	30.0	29.6	29.3	28.9	28.6	22
24	26.9	26.8	26.3	26.2	25.8	25.6	25.1	24.9	24
26	23.8	23.7	23.3	23.2	22.7	22.6	22.1	22.0	26
28	24.9m x	24.9m x	24.9m x	24.9m x	24.9m x	24.9m x	24.9m x	24.9m x	28
	22.5t	22.5t	22.0t	22.0t	21.5t	21.4t	20.9t	20.8t	

- The rated loads are determined according to EN13000 rating on the condition that the machine is stationed on firm level ground.
- The figures surrounded by bold lines are based on factors other than those which would cause a tipping condition.
- Be sure to attach the hanger sheaves block to the top boom when boom length is 15m and 18m.
- Be sure to remove the hanger sheaves block from the top boom when boom length is 24m or more.
- To calculate the maximum load that can actually be lifted, deduct mass of all lifting accessories, such as hook, from figures shown above.
- Working radius is the horizontal distance from the swing center to the center of gravity of a lifted load.
- The counter weight is 83 ton. (Superstructure 67 ton + lower weight 16 ton)
- Figures described as OOm x OOt in the tables indicate "working radius" m x "rated load" ton.
- Correlation between the number of reeved lines, maximum rated loads, hook mass are shown in the table below.

Hook Capacity (t)	Hook Weight (t)	Maximum Rated Loads (t)									
		10 falls	9 falls	8 falls	7 falls	6 falls	5 falls	4 falls	3 falls	2 falls	1 fall
175	3.34	135	121.5	108	94.5	81	67.5	54	40.5	27	-
160	2.59	135	121.5	108	94.5	81	67.5	54	40.5	27	-
135	2.35	135	121.5	108	94.5	81	67.5	54	40.5	27	-
80	1.35	-	-	-	-	80	67.5	54	40.5	27	-
35	1.07	-	-	-	-	-	-	-	35	27	-
13.5	0.62	-	-	-	-	-	-	-	-	-	13.5

■ Main Boom with Crane Jib



Unit: ton

Boom Length (m)	30								Boom Length (m)
Jib Length (m)	13		19		25		31		Jib Length (m)
Offset Angle (°)	10	30	10	30	10	30	10	30	Offset Angle (°)
Working Radius (m)	10	30	10	30	10	30	10	30	Working Radius (m)
6	7.1m x	7.1m x	7.1m x	7.1m x	7.1m x	7.1m x	7.1m x	7.1m x	6
7	96.0t	96.0t	96.0t	96.0t	96.0t	96.0t	96.0t	96.0t	7
8	91.9	91.6	91.4	90.8	90.9	90.0	90.3	89.1	8
9	81.5	81.2	81.0	80.5	80.5	79.7	79.9	78.9	9
10	73.1	72.8	72.6	72.2	72.1	71.4	71.5	70.6	10
12	60.3	60.1	59.9	59.5	59.3	58.8	58.8	58.1	12
14	50.5	50.2	49.9	49.5	49.3	48.7	48.6	47.8	14
16	41.9	41.7	41.3	41.0	40.7	40.3	40.0	39.4	16
18	35.5	35.4	35.0	34.7	34.4	34.0	33.7	33.3	18
20	30.7	30.5	30.1	30.0	29.6	29.3	28.9	28.6	20
22	26.8	26.7	26.3	26.2	25.8	25.6	25.1	24.9	22
24	23.7	23.7	23.2	23.1	22.7	22.5	22.1	21.9	24
26	21.2	21.1	20.7	20.6	20.2	20.1	19.6	19.4	26
28	27.5m x	27.5m x	27.5m x	27.5m x	27.5m x	27.5m x	27.5m x	27.5m x	28
30	19.5t	19.5t	19.1t	19.0t	18.5t	18.5t	18.0t	17.9t	30

Unit: ton

Boom Length (m)	33								Boom Length (m)
Jib Length (m)	13		19		25		31		Jib Length (m)
Offset Angle (°)	10	30	10	30	10	30	10	30	Offset Angle (°)
Working Radius (m)	10	30	10	30	10	30	10	30	Working Radius (m)
6	7.6m x	7.6m x	7.6m x	7.6m x	7.6m x	7.6m x	7.6m x	7.6m x	6
7	84.0t	84.0t	84.0t	84.0t	84.0t	84.0t	84.0t	84.0t	7
8	84.0	84.0	84.0	84.0	84.0	84.0	84.0	84.0	8
9	81.4	81.1	80.9	80.4	80.4	79.6	79.8	78.8	9
10	73.0	72.7	72.5	72.1	72.0	71.3	71.4	70.5	10
12	60.2	60.0	59.8	59.4	59.3	58.7	58.7	58.0	12
14	50.4	50.2	49.9	49.5	49.3	48.7	48.6	47.8	14
16	41.8	41.6	41.3	40.9	40.7	40.2	40.0	39.4	16
18	35.5	35.3	34.9	34.7	34.4	34.0	33.7	33.2	18
20	30.6	30.5	30.1	29.9	29.5	29.2	28.9	28.5	20
22	26.8	26.6	26.3	26.1	25.7	25.5	25.1	24.8	22
24	23.6	23.6	23.2	23.0	22.6	22.4	22.0	21.8	24
26	21.1	21.0	20.6	20.5	20.1	19.9	19.5	19.3	26
28	18.9	18.9	18.5	18.4	18.0	17.9	17.4	17.3	28
30	17.1	17.1	16.7	16.6	16.2	16.1	15.6	15.5	30
32	30.1m x	30.1m x	30.1m x	30.1m x	30.1m x	30.1m x	30.1m x	30.1m x	32
	17.0t	17.0t	16.6t	16.5t	16.1t	16.0t	15.5t	15.5t	

Unit: ton

Boom Length (m)	36								Boom Length (m)
Jib Length (m)	13		19		25		31		Jib Length (m)
Offset Angle (°)	10	30	10	30	10	30	10	30	Offset Angle (°)
Working Radius (m)	10	30	10	30	10	30	10	30	Working Radius (m)
8.2	84.0	84.0	84.0	84.0	84.0	84.0	84.0	83.0	8.2
9	78.7	78.3	78.1	77.5	77.4	76.5	76.7	75.4	9
10	72.7	72.4	72.3	71.8	71.8	71.1	71.2	70.3	10
12	59.9	59.7	59.5	59.1	59.0	58.5	58.5	57.7	12
14	50.3	50.0	49.7	49.3	49.1	48.5	48.5	47.6	14
16	41.6	41.4	41.1	40.7	40.5	40.0	39.9	39.2	16
18	35.2	35.1	34.8	34.5	34.2	33.8	33.6	33.0	18
20	30.4	30.2	29.9	29.7	29.4	29.0	28.8	28.3	20
22	26.5	26.4	26.1	25.9	25.5	25.3	25.0	24.6	22
24	23.4	23.3	23.0	22.8	22.4	22.2	21.9	21.6	24
26	20.9	20.8	20.4	20.3	19.9	19.7	19.3	19.1	26
28	18.7	18.6	18.2	18.1	17.8	17.6	17.2	17.0	28
30	16.9	16.8	16.4	16.4	15.9	15.8	15.4	15.3	30
32	15.3	15.3	14.9	14.8	14.4	14.3	13.9	13.8	32
34	32.7m x	32.7m x	32.7m x	32.7m x	32.7m x	32.7m x	32.7m x	32.7m x	34
36	14.8t	14.8t	14.4t	14.3t	13.9t	13.9t	13.4t	13.3t	36

* For notes about the table above, refer to page 37.

■ Main Boom with Crane Jib



Unit: ton

Boom Length (m)	39								Boom Length (m)
Jib Length (m)	13		19		25		31		Jib Length (m)
Offset Angle (°)	10	30	10	30	10	30	10	30	Offset Angle (°)
Working Radius (m)	10	30	10	30	10	30	10	30	Working Radius (m)
8	8.7m x	8.7m x	8.7m x	8.7m x	8.7m x	8.7m x	8.7m x	8.7m x	8
9	72.0t	72.0t	72.0t	72.0t	72.0t	72.0t	72.0t	72.0t	9
10	72.0	72.0	72.0	72.0	72.0	72.0	72.0	72.0	10
12	70.4	70.1	69.8	69.3	69.2	68.4	68.5	67.3	12
14	58.2	57.9	57.6	57.1	57.0	56.3	56.3	55.4	14
16	49.2	49.0	48.7	48.3	48.1	47.5	47.4	46.7	16
18	41.6	41.3	41.1	40.7	40.5	40.0	39.9	39.2	18
20	35.2	35.0	34.7	34.4	34.2	33.7	33.6	33.0	20
22	30.3	30.2	29.8	29.6	29.3	29.0	28.7	28.3	22
24	26.5	26.3	26.0	25.8	25.5	25.2	24.9	24.5	24
26	23.4	23.2	22.9	22.7	22.4	22.1	21.8	21.5	26
28	20.8	20.7	20.3	20.2	19.8	19.6	19.3	19.0	28
30	18.6	18.5	18.2	18.1	17.7	17.5	17.2	16.9	30
32	16.8	16.7	16.3	16.2	15.9	15.7	15.3	15.2	32
34	15.2	15.1	14.8	14.7	14.3	14.2	13.8	13.7	34
36	13.8	13.8	13.4	13.4	12.9	12.9	12.4	12.4	36
38	35.3m x	35.3m x	35.3m x	35.3m x	35.3m x	35.3m x	35.3m x	35.3m x	38
	13.0t	13.0t	12.6t	12.6t	12.2t	12.1t	11.7t	11.6t	

Unit: ton

Boom Length (m)	42								Boom Length (m)
Jib Length (m)	13		19		25		31		Jib Length (m)
Offset Angle (°)	10	30	10	30	10	30	10	30	Offset Angle (°)
Working Radius (m)	10	30	10	30	10	30	10	30	Working Radius (m)
8	9.2m x	9.2m x	9.2m x	9.2m x	9.2m x	9.2m x	9.2m x	9.2m x	8
9	67.5t	67.5t	67.5t	67.5t	67.5t	67.5t	67.5t	67.5t	9
10	67.5	67.5	67.5	67.5	67.5	67.5	67.5	67.1	10
12	58.0	57.7	57.4	56.9	56.8	56.1	56.1	55.2	12
14	49.0	48.8	48.5	48.1	47.9	47.3	47.2	46.5	14
16	41.4	41.2	40.9	40.5	40.4	39.8	39.8	39.0	16
18	35.0	34.8	34.6	34.2	34.0	33.6	33.5	32.8	18
20	30.2	30.0	29.7	29.4	29.2	28.8	28.6	28.1	20
22	26.3	26.2	25.8	25.6	25.3	25.0	24.8	24.4	22
24	23.2	23.1	22.7	22.5	22.2	22.0	21.7	21.3	24
26	20.6	20.5	20.2	20.0	19.7	19.5	19.1	18.9	26
28	18.4	18.3	18.0	17.9	17.5	17.3	17.0	16.8	28
30	16.6	16.5	16.2	16.1	15.7	15.5	15.2	15.0	30
32	15.0	14.9	14.6	14.5	14.1	14.0	13.6	13.5	32
34	13.6	13.6	13.2	13.2	12.8	12.7	12.3	12.2	34
36	12.4	12.4	12.0	12.0	11.6	11.5	11.1	11.0	36
38	37.9m x	37.9m x	37.9m x	37.9m x	37.9m x	37.9m x	37.9m x	37.9m x	38
40	11.4t	11.4t	11.0t	11.0t	10.6t	10.6t	10.1t	10.1t	40

Unit: ton

Boom Length (m)	45								Boom Length (m)
Jib Length (m)	13		19		25		31		Jib Length (m)
Offset Angle (°)	10	30	10	30	10	30	10	30	Offset Angle (°)
Working Radius (m)	10	30	10	30	10	30	10	30	Working Radius (m)
8	9.7m x	9.7m x	9.7m x	9.7m x	9.7m x	9.7m x	9.7m x	9.7m x	8
9	60.0t	60.0t	60.0t	60.0t	60.0t	60.0t	60.0t	60.0t	9
10	60.0	60.0	60.0	60.0	60.0	60.0	60.0	60.0	10
12	57.6	57.3	57.1	56.6	56.5	55.8	55.8	54.8	12
14	48.7	48.5	48.2	47.8	47.6	47.0	47.0	46.2	14
16	41.3	41.1	40.8	40.4	40.3	39.7	39.7	38.9	16
18	34.9	34.7	34.4	34.1	33.9	33.5	33.4	32.7	18
20	30.0	29.9	29.6	29.3	29.1	28.7	28.5	28.0	20
22	26.2	26.0	25.7	25.5	25.2	24.9	24.7	24.2	22
24	23.0	22.9	22.6	22.4	22.1	21.8	21.6	21.2	24
26	20.4	20.3	20.0	19.8	19.5	19.3	19.0	18.7	26
28	18.3	18.2	17.8	17.7	17.4	17.2	16.9	16.6	28
30	16.4	16.3	16.0	15.9	15.5	15.4	15.1	14.8	30
32	14.8	14.8	14.4	14.3	14.0	13.8	13.5	13.3	32
34	13.5	13.4	13.0	13.0	12.6	12.5	12.1	12.0	34
36	12.2	12.2	11.8	11.8	11.4	11.3	10.9	10.8	36
38	11.2	11.1	10.8	10.7	10.3	10.3	9.9	9.8	38
40	10.2	10.2	9.8	9.8	9.4	9.4	9.0	8.9	40
42	40.5m x	40.5m x	40.5m x	40.5m x	40.5m x	40.5m x	40.5m x	40.5m x	42
	10.0t	10.0t	9.6t	9.6t	9.2t	9.2t	8.7t	8.7t	

* For notes about the table above, refer to page 37.

■ Main Boom with Crane Jib



Unit: ton

Boom Length (m)	48								Boom Length (m)
Jib Length (m)	13		19		25		31		Jib Length (m)
Offset Angle (°)	10	30	10	30	10	30	10	30	Offset Angle (°)
Working Radius (m)	10	30	10	30	10	30	10	30	Working Radius (m)
10.2	60.0	60.0	60.0	60.0	60.0	60.0	60.0	60.0	10.2
12	54.4	54.1	53.9	53.4	53.3	52.7	52.7	51.8	12
14	46.3	46.1	45.8	45.4	45.3	44.7	44.6	43.9	14
16	40.1	39.9	39.6	39.3	39.1	38.6	38.5	37.8	16
18	34.8	34.6	34.3	34.0	33.8	33.3	33.2	32.6	18
20	29.9	29.7	29.4	29.1	28.9	28.5	28.4	27.8	20
22	26.0	25.8	25.6	25.3	25.1	24.7	24.6	24.1	22
24	22.9	22.7	22.4	22.2	22.0	21.7	21.5	21.1	24
26	20.3	20.2	19.9	19.7	19.4	19.1	18.9	18.5	26
28	18.1	18.0	17.7	17.5	17.2	17.0	16.7	16.4	28
30	16.3	16.2	15.8	15.7	15.4	15.2	14.9	14.7	30
32	14.7	14.6	14.3	14.1	13.8	13.7	13.3	13.1	32
34	13.3	13.2	12.9	12.8	12.4	12.3	12.0	11.8	34
36	12.1	12.0	11.7	11.6	11.2	11.1	10.8	10.6	36
38	11.0	10.9	10.6	10.5	10.2	10.1	9.7	9.6	38
40	10.0	10.0	9.7	9.6	9.2	9.2	8.8	8.7	40
42	9.2	9.2	8.8	8.8	8.4	8.4	8.0	7.9	42
44	43.1m x	43.1m x	43.1m x	43.1m x	43.1m x	43.1m x	43.1m x	43.1m x	44
46	8.8t	8.7t	8.4t	8.4t	8.0t	8.0t	7.5t	7.5t	46

Unit: ton

Boom Length (m)	51								Boom Length (m)
Jib Length (m)	13		19		25		31		Jib Length (m)
Offset Angle (°)	10	30	10	30	10	30	10	30	Offset Angle (°)
Working Radius (m)	10.8m x	10.8m x	10.8m x	10.8m x	10.8m x	10.8m x	10.8m x	10.8m x	Working Radius (m)
10	48.0t	48.0t	48.0t	48.0t	48.0t	48.0t	48.0t	48.0t	10
12	48.0	48.0	48.0	48.0	48.0	48.0	48.0	48.0	12
14	46.0	45.8	45.5	45.1	45.0	44.4	44.4	43.6	14
16	39.8	39.6	39.3	39.0	38.8	38.3	38.2	37.5	16
18	34.7	34.5	34.2	33.9	33.7	33.3	33.2	32.5	18
20	29.8	29.6	29.4	29.1	28.9	28.5	28.3	27.8	20
22	25.9	25.8	25.5	25.2	25.0	24.7	24.5	24.0	22
24	22.8	22.6	22.4	22.1	21.9	21.6	21.4	21.0	24
26	20.2	20.1	19.8	19.6	19.3	19.1	18.8	18.5	26
28	18.0	17.9	17.6	17.4	17.2	16.9	16.7	16.4	28
30	16.2	16.1	15.8	15.6	15.3	15.1	14.8	14.6	30
32	14.6	14.5	14.2	14.0	13.7	13.5	13.3	13.0	32
34	13.2	13.1	12.8	12.7	12.3	12.2	11.9	11.7	34
36	12.0	11.9	11.6	11.5	11.1	11.0	10.7	10.5	36
38	10.9	10.8	10.5	10.4	10.1	10.0	9.6	9.5	38
40	9.9	9.9	9.5	9.5	9.1	9.0	8.7	8.6	40
42	9.1	9.0	8.7	8.6	8.3	8.2	7.8	7.7	42
44	8.3	8.3	7.9	7.9	7.5	7.5	7.1	7.0	44
46	45.7m x	45.7m x	45.7m x	45.7m x	45.7m x	45.7m x	45.7m x	45.7m x	46
48	7.7t	7.7t	7.3t	7.3t	6.9t	6.9t	6.5t	6.5t	48

* For notes about the table above, refer to page 37.

■ Main Boom with Crane Jib



Unit: ton

Boom Length (m)	54								Boom Length (m)
Jib Length (m)	13		19		25		31		Jib Length (m)
Offset Angle (°)	10	30	10	30	10	30	10	30	Offset Angle (°)
Working Radius (m)									Working Radius (m)
10	11.3m x 48.0t	11.3m x 48.0t	11.3m x 48.0t	11.3m x 48.0t	11.3m x 48.0t	11.3m x 48.0t	11.3m x 48.0t	11.3m x 48.0t	10
12	48.0	48.0	48.0	48.0	48.0	48.0	48.0	48.0	12
14	45.8	45.5	45.2	44.8	44.7	44.1	44.1	43.3	14
16	39.5	39.3	39.0	38.7	38.5	38.0	37.9	37.2	16
18	34.5	34.3	34.0	33.7	33.6	33.0	33.0	32.3	18
20	29.6	29.4	29.1	28.8	28.7	28.2	28.2	27.6	20
22	25.7	25.5	25.3	25.0	24.8	24.4	24.3	23.8	22
24	22.6	22.4	22.1	21.9	21.7	21.4	21.2	20.8	24
26	20.0	19.8	19.5	19.4	19.1	18.8	18.6	18.2	26
28	17.8	17.7	17.4	17.2	16.9	16.7	16.5	16.1	28
30	15.9	15.8	15.5	15.4	15.1	14.9	14.6	14.3	30
32	14.3	14.2	13.9	13.8	13.5	13.3	13.0	12.8	32
34	12.9	12.8	12.5	12.4	12.1	11.9	11.7	11.4	34
36	11.7	11.6	11.3	11.2	10.9	10.8	10.4	10.3	36
38	10.6	10.6	10.2	10.2	9.8	9.7	9.4	9.2	38
40	9.7	9.6	9.3	9.2	8.9	8.8	8.4	8.3	40
42	8.8	8.8	8.4	8.4	8.0	7.9	7.6	7.5	42
44	8.0	8.0	7.7	7.6	7.3	7.2	6.8	6.7	44
46	7.3	7.3	7.0	6.9	6.6	6.5	6.1	6.1	46
48	6.7	6.7	6.3	6.3	6.0	5.9	5.5	5.5	48
50	48.3m x 6.6t	48.3m x 6.6t	48.3m x 6.3t	48.3m x 6.2t	48.3m x 5.9t	48.3m x 5.8t	48.3m x 5.5t	48.3m x 5.4t	50
52									52

Unit: ton

Boom Length (m)	57								Boom Length (m)
Jib Length (m)	13		19		25		31		Jib Length (m)
Offset Angle (°)	10	30	10	30	10	30	10	30	Offset Angle (°)
Working Radius (m)									Working Radius (m)
10	11.8m x 48.0t	11.8m x 48.0t	11.8m x 48.0t	11.8m x 48.0t	11.8m x 48.0t	11.8m x 48.0t	11.8m x 48.0t	11.8m x 48.0t	10
12	48.0	48.0	48.0	48.0	48.0	48.0	48.0	48.0	12
14	43.5	43.3	43.1	42.7	42.5	42.0	42.0	41.2	14
16	37.8	37.6	37.3	37.0	36.8	36.3	36.2	35.6	16
18	34.3	34.1	33.9	33.5	33.4	32.9	32.8	32.2	18
20	29.4	29.2	29.0	28.7	28.5	28.1	28.0	27.4	20
22	25.5	25.4	25.1	24.8	24.6	24.3	24.2	23.6	22
24	22.4	22.2	22.0	21.7	21.5	21.2	21.0	20.6	24
26	19.8	19.6	19.4	19.2	18.9	18.6	18.5	18.1	26
28	17.6	17.5	17.2	17.0	16.8	16.5	16.3	16.0	28
30	15.7	15.6	15.3	15.2	14.9	14.7	14.5	14.2	30
32	14.1	14.0	13.7	13.6	13.3	13.1	12.9	12.6	32
34	12.7	12.7	12.4	12.2	11.9	11.8	11.5	11.3	34
36	11.5	11.4	11.1	11.0	10.7	10.6	10.3	10.1	36
38	10.4	10.4	10.1	10.0	9.6	9.5	9.2	9.0	38
40	9.5	9.4	9.1	9.0	8.7	8.6	8.3	8.1	40
42	8.6	8.6	8.2	8.2	7.8	7.7	7.4	7.3	42
44	7.8	7.8	7.5	7.4	7.1	7.0	6.6	6.5	44
46	7.1	7.1	6.8	6.7	6.4	6.3	6.0	5.9	46
48	6.5	6.5	6.2	6.1	5.8	5.7	5.3	5.3	48
50	5.9	5.9	5.6	5.6	5.2	5.2	4.8	4.7	50
52	50.9m x 5.7t	50.9m x 5.7t	50.9m x 5.3t	50.9m x 5.3t	50.9m x 5.0t	50.9m x 4.9t	50.9m x 4.6t	50.9m x 4.5t	52

* For notes about the table above, refer to page 37.

■ Main Boom with Crane Jib



Unit: ton

Boom Length (m)	60								Boom Length (m)
Jib Length (m)	13		19		25		31		Jib Length (m)
Offset Angle (°)	10	30	10	30	10	30	10	30	Offset Angle (°)
Working Radius (m)									Working Radius (m)
12.3	40.5	40.5	40.5	40.5	40.5	40.5	40.5	40.5	12.3
14	40.5	40.5	40.5	40.5	40.5	40.5	40.5	40.5	14
16	37.5	37.3	37.1	36.7	36.6	36.1	36.0	35.3	16
18	33.0	32.8	32.5	32.2	32.0	31.5	31.4	30.8	18
20	29.2	29.0	28.7	28.5	28.2	27.8	27.7	27.2	20
22	25.3	25.2	24.9	24.6	24.5	24.1	24.0	23.5	22
24	22.2	22.0	21.8	21.5	21.3	21.0	20.9	20.4	24
26	19.6	19.4	19.2	19.0	18.7	18.4	18.3	17.9	26
28	17.4	17.3	17.0	16.8	16.6	16.3	16.1	15.8	28
30	15.5	15.4	15.1	15.0	14.7	14.5	14.3	14.0	30
32	13.9	13.8	13.5	13.4	13.1	12.9	12.7	12.4	32
34	12.5	12.4	12.2	12.0	11.7	11.6	11.3	11.1	34
36	11.3	11.2	10.9	10.8	10.5	10.4	10.1	9.9	36
38	10.2	10.2	9.9	9.8	9.4	9.3	9.0	8.8	38
40	9.3	9.2	8.9	8.8	8.5	8.4	8.1	7.9	40
42	8.4	8.3	8.0	8.0	7.6	7.5	7.2	7.1	42
44	7.6	7.6	7.3	7.2	6.9	6.8	6.4	6.3	44
46	6.9	6.9	6.6	6.5	6.2	6.1	5.8	5.7	46
48	6.3	6.3	5.9	5.9	5.6	5.5	5.1	5.1	48
50	5.7	5.7	5.4	5.3	5.0	4.9	4.6	4.5	50
52	5.2	5.2	4.8	4.8	4.5	4.4	4.1	4.0	52
54	53.5m x	53.5m x	53.5m x	53.5m x	53.5m x	53.5m x	53.5m x	53.5m x	54
56	4.8t	4.8t	4.5t	4.5t	4.1t	4.1t	3.7t	3.7t	56

Unit: ton

Boom Length (m)	63								Boom Length (m)
Jib Length (m)	13		19		25		31		Jib Length (m)
Offset Angle (°)	10	30	10	30	10	30	10	30	Offset Angle (°)
Working Radius (m)									Working Radius (m)
12	12.8m x	12.8m x	12.8m x	12.8m x	12.8m x	12.8m x	12.8m x	12.8m x	12
14	36.0t	36.0t	36.0t	36.0t	36.0t	36.0t	36.0t	36.0t	14
16	36.0	36.0	36.0	36.0	36.0	35.7	35.6	34.9	16
18	32.6	32.4	32.1	31.8	31.6	31.2	31.1	30.5	18
20	28.8	28.6	28.4	28.1	27.9	27.5	27.3	26.8	20
22	25.2	25.1	24.8	24.6	24.4	24.0	23.9	23.4	22
24	22.1	21.9	21.7	21.4	21.3	20.9	20.8	20.3	24
26	19.5	19.3	19.1	18.9	18.7	18.3	18.2	17.8	26
28	17.3	17.2	16.9	16.7	16.5	16.2	16.0	15.7	28
30	15.4	15.3	15.0	14.9	14.6	14.4	14.2	13.8	30
32	13.8	13.7	13.4	13.3	13.0	12.8	12.6	12.3	32
34	12.4	12.3	12.0	11.9	11.6	11.4	11.2	10.9	34
36	11.2	11.1	10.8	10.7	10.4	10.2	10.0	9.7	36
38	10.1	10.0	9.7	9.6	9.3	9.2	8.9	8.7	38
40	9.1	9.1	8.8	8.7	8.4	8.2	7.9	7.8	40
42	8.3	8.2	7.9	7.8	7.5	7.4	7.1	6.9	42
44	7.5	7.4	7.1	7.0	6.7	6.6	6.3	6.2	44
46	6.8	6.7	6.4	6.3	6.0	5.9	5.6	5.5	46
48	6.1	6.1	5.8	5.7	5.4	5.3	5.0	4.9	48
50	5.5	5.5	5.2	5.1	4.8	4.7	4.4	4.3	50
52	5.0	5.0	4.7	4.6	4.3	4.2	3.9	3.8	52
54	4.5	4.5	4.2	4.1	3.8	3.8	3.4	3.4	54
56	4.1	4.1	3.7	3.7	3.4	3.3	3.0	2.9	56
58	56.1m x	56.1m x	56.1m x	56.1m x	56.1m x	56.1m x	56.1m x	56.1m x	58
60	4.1t	4.0t	3.7t	3.7t	3.3t	3.3t	3.0t	2.9t	60

* For notes about the table above, refer to page 37.

■ Main Boom with Crane Jib



Unit: ton

Boom Length (m)	66								Boom Length (m)
Jib Length (m)	13		19		25		31		Jib Length (m)
Offset Angle (°)	10	30	10	30	10	30	10	30	Offset Angle (°)
Working Radius (m)									Working Radius (m)
12	13.4m x	13.4m x	13.4m x	13.4m x	13.4m x	13.4m x	13.4m x	13.4m x	12
14	36.0t	36.0t	36.0t	36.0t	36.0t	35.9t	35.5t	35.2t	14
16	36.0	36.0	36.0	36.0	35.5	35.3	34.9	34.6	16
18	34.5	34.5	34.0	34.0	33.5	33.4	32.9	32.7	18
20	32.3	32.1	31.9	31.5	31.4	30.9	30.8	30.2	20
22	28.6	28.4	28.1	27.8	27.6	27.2	27.1	26.6	22
24	25.1	24.9	24.7	24.4	24.2	23.8	23.7	23.2	24
26	21.9	21.7	21.5	21.3	21.1	20.7	20.6	20.1	26
28	19.3	19.2	18.9	18.7	18.5	18.2	18.0	17.6	28
30	17.1	17.0	16.7	16.5	16.3	16.0	15.9	15.5	30
32	15.2	15.1	14.9	14.7	14.4	14.2	14.0	13.7	32
34	13.6	13.5	13.3	13.1	12.8	12.6	12.4	12.1	34
36	12.2	12.1	11.9	11.7	11.5	11.2	11.0	10.7	36
38	11.0	10.9	10.6	10.5	10.2	10.0	9.8	9.6	38
40	9.9	9.8	9.5	9.4	9.1	9.0	8.7	8.5	40
42	8.9	8.9	8.6	8.5	8.2	8.0	7.8	7.6	42
44	8.1	8.0	7.7	7.6	7.3	7.2	6.9	6.7	44
46	7.3	7.2	6.9	6.8	6.5	6.4	6.1	6.0	46
48	6.6	6.5	6.2	6.1	5.8	5.7	5.4	5.3	48
50	5.9	5.9	5.6	5.5	5.2	5.1	4.8	4.7	50
52	5.3	5.3	5.0	4.9	4.6	4.5	4.2	4.1	52
54	4.8	4.8	4.5	4.4	4.1	4.0	3.7	3.6	54
56	4.3	4.3	4.0	3.9	3.6	3.6	3.2	3.1	56
58	3.9	3.8	3.5	3.5	3.2	3.1	2.8	2.7	58
60	3.5	3.4	3.1	3.1	2.8	2.7	2.4	2.3	60
62	58.7m x	58.7m x	58.7m x	58.7m x	58.7m x	58.7m x	58.7m x	58.7m x	62
	3.3t	3.3t	3.0t	3.0t	2.6t	2.6t	2.2t	2.2t	

Unit: ton

Boom Length (m)	69								Boom Length (m)
Jib Length (m)	13		19		25		31		Jib Length (m)
Offset Angle (°)	10	30	10	30	10	30	10	30	Offset Angle (°)
Working Radius (m)									Working Radius (m)
12	13.9m x	13.9m x	13.9m x	13.9m x	13.9m x	13.9m x	13.9m x	13.9m x	12
14	33.4t	33.3t	32.8t	32.7t	32.3t	32.0t	31.7t	31.3t	14
16	33.3	33.2	32.8	32.6	32.2	32.0	31.6	31.2	16
18	31.4	31.3	30.9	30.8	30.4	30.2	29.8	29.6	18
20	29.5	29.5	29.1	29.0	28.6	28.5	28.0	27.9	20
22	27.5	27.3	27.0	26.7	26.5	26.1	26.0	25.5	22
24	24.5	24.3	24.1	23.8	23.6	23.2	23.1	22.6	24
26	21.7	21.6	21.3	21.1	20.9	20.5	20.4	19.9	26
28	19.1	19.0	18.7	18.5	18.3	18.0	17.8	17.4	28
30	16.9	16.8	16.5	16.3	16.1	15.8	15.7	15.3	30
32	15.0	14.9	14.7	14.5	14.3	14.0	13.8	13.5	32
34	13.4	13.3	13.1	12.9	12.6	12.4	12.2	11.9	34
36	12.0	11.9	11.7	11.5	11.3	11.0	10.8	10.5	36
38	10.8	10.7	10.4	10.3	10.0	9.8	9.6	9.4	38
40	9.7	9.6	9.3	9.2	8.9	8.8	8.5	8.3	40
42	8.7	8.7	8.4	8.3	8.0	7.8	7.6	7.4	42
44	7.9	7.8	7.5	7.4	7.1	7.0	6.7	6.5	44
46	7.1	7.0	6.7	6.6	6.3	6.2	5.9	5.8	46
48	6.4	6.3	6.0	5.9	5.6	5.5	5.2	5.1	48
50	5.7	5.7	5.4	5.3	5.0	4.9	4.6	4.5	50
52	5.1	5.1	4.8	4.7	4.4	4.3	4.0	3.9	52
54	4.6	4.6	4.3	4.2	3.9	3.8	3.5	3.4	54
56	4.1	4.1	3.8	3.7	3.4	3.3	3.0	2.9	56
58	3.7	3.6	3.3	3.3	2.9	2.9	2.6	2.5	58
60	3.2	3.2	2.9	2.9	2.5	2.5	2.2	2.1	60
62	2.9	2.8	2.5	2.5	2.2	2.1	59.6m x	59.4m x	62
	61.3m x	61.3m x	61.3m x	61.3m x	61.3m x	61.3m x	1.9t	1.9t	
	2.6t	2.6t	2.3t	2.3t	1.9t	1.9t			

* For notes about the table above, refer to page 37.

■ Main Boom with Crane Jib



Unit: ton

Boom Length (m)	72								Boom Length (m)
Jib Length (m)	13		19		25		31		Jib Length (m)
Offset Angle (°)	10	30	10	30	10	30	10	30	Offset Angle (°)
Working Radius (m)	10	30	10	30	10	30	10	30	Working Radius (m)
14.4	27.0	27.0	27.0	27.0	27.0	27.0	27.0	27.0	14.4
16	27.0	27.0	27.0	27.0	27.0	27.0	26.8	26.5	16
18	26.7	26.6	26.2	26.2	25.7	25.6	25.2	25.0	18
20	25.0	24.9	24.5	24.5	24.1	24.0	23.6	23.5	20
22	23.3	23.3	22.9	22.9	22.5	22.5	22.0	22.0	22
24	21.5	21.3	21.1	20.8	20.7	20.3	20.2	19.7	24
26	18.9	18.7	18.5	18.3	18.1	17.7	17.6	17.2	26
28	16.7	16.5	16.3	16.1	15.9	15.6	15.4	15.0	28
30	14.8	14.7	14.4	14.2	14.0	13.8	13.6	13.2	30
32	13.2	13.1	12.8	12.6	12.4	12.2	12.0	11.7	32
34	11.8	11.7	11.4	11.3	11.0	10.8	10.6	10.3	34
36	10.5	10.5	10.2	10.0	9.8	9.6	9.4	9.1	36
38	9.5	9.4	9.1	9.0	8.7	8.5	8.3	8.1	38
40	8.5	8.4	8.1	8.0	7.7	7.6	7.3	7.1	40
42	7.6	7.5	7.3	7.1	6.9	6.7	6.5	6.3	42
44	6.8	6.8	6.5	6.4	6.1	6.0	5.7	5.5	44
46	6.1	6.1	5.8	5.7	5.4	5.3	5.0	4.8	46
48	5.5	5.4	5.1	5.0	4.7	4.6	4.3	4.2	48
50	4.9	4.8	4.5	4.5	4.2	4.1	3.8	3.6	50
52	4.3	4.3	4.0	3.9	3.6	3.5	3.2	3.1	52
54	3.8	3.8	3.5	3.4	3.1	3.1	2.7	2.7	54
56	3.4	3.4	3.1	3.0	2.7	2.6	2.3	2.2	56
58	3.0	2.9	2.6	2.6	2.3	2.2	1.9	57.8m x 1.9t	58
60	2.6	2.6	2.2	2.2	1.9	1.9	58.2m x 1.9t	1.9t	60
62	2.2	2.2	1.9	1.9	60.2m x 1.9t		1.9t		62
64	63.9m x 1.9t	63.9m x 1.9t	62.2m x 1.9t	62.1m x 1.9t					64
66									66

* For notes about the table above, refer to page 37.

Weights and Dimensions of Disassembled Units

Weights and Dimensions List

Comply with the regulations when transporting.

"Weight" refers to the mass of each single unit.

Weights and Dimensions of Disassembled Units

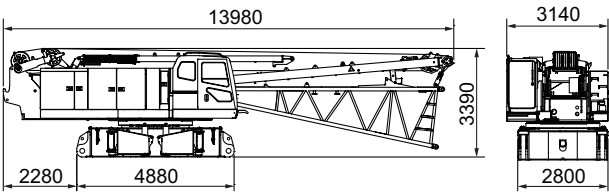
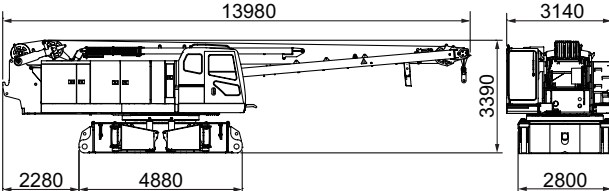
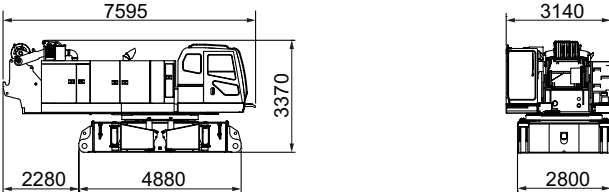
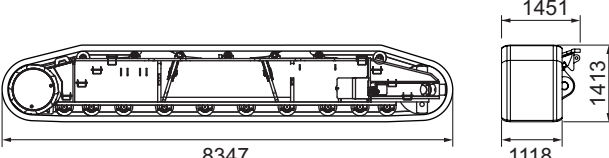
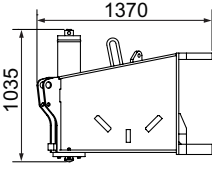
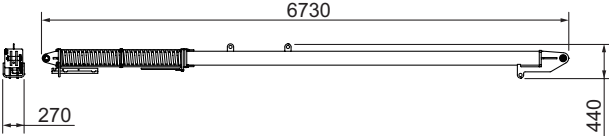
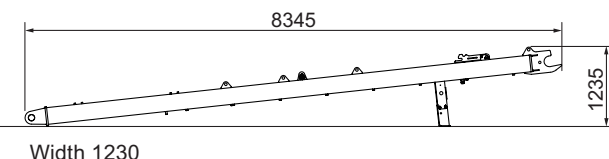
Description	Qty	Dimensions (mm)	Weight (kg)
Base Crane with: Backstop Boom Base Mast Front Winch Wire Rope Jacks Upper & Lower Spreader Floats	1		38300
Base Crane with: Backstop Mast Front Winch Wire Rope Jacks Upper & Lower Spreader Floats	1		36100
Base Crane with: Jacks Upper & Lower Spreader Floats Without: Backstop Boom Base Mast Front Winch Wire Rope	1		32400
Crawler (Assembly) (Lower Roller : 10 Pieces)	2		18900
Jack Beams	4		430
Boom Backstop	2		460
Mast	1		1700

• With upper house handrails, the weight of the main unit increases by 105 kg.

• With catwalks, the weight of the main unit increases by 195 kg and the width of the main unit increases by 210 mm.

Weights and Dimensions of Disassembled Units

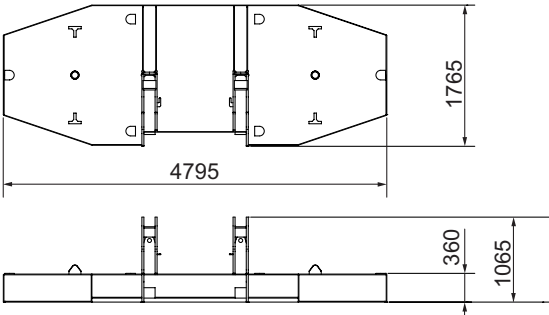
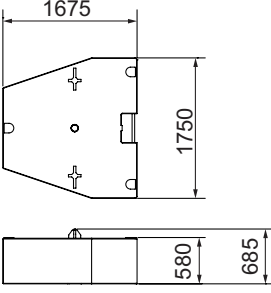
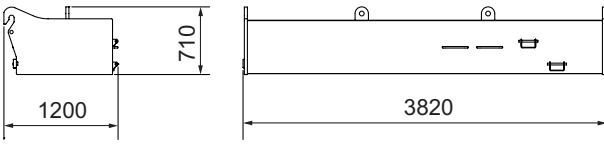
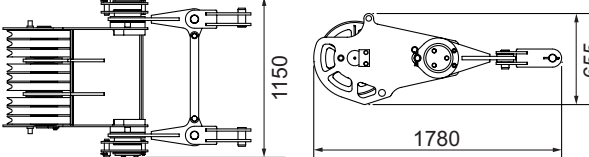
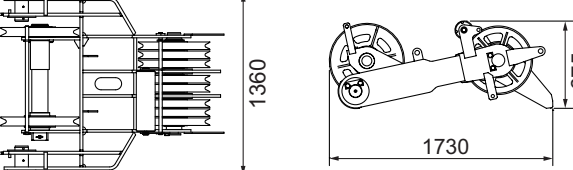
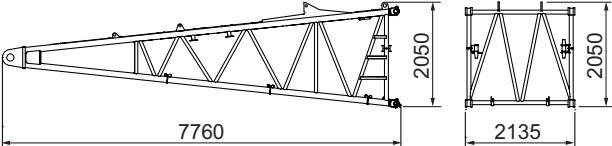
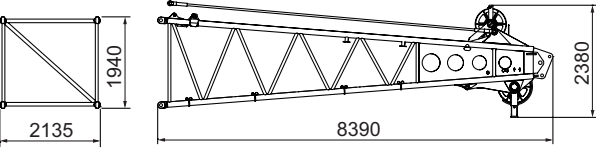
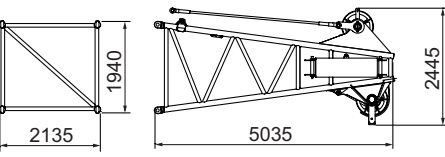
Description	Qty	Dimensions (mm)	Weight (kg)
Counter Weight (Base)	1		12000
Counter Weight	8		6880
Lower Weight	2		8000
Upper Spreader	1		860
Lower Spreader	1		930
Boom Base	1		2200
Boom Top	1		2600
175 t Boom Top	1		3800

Weights and Dimensions of Disassembled Units

Description	Qty	Dimensions (mm)	Weight (kg)
3 m Boom Insert	1		600
6 m Boom Insert	1		1000
9 m Boom Insert	1		1300
Jib Base (With Jib Strut)	1		580
Jib Top	1		290
3 m Jib Insert	1		120
6 m Jib Insert	1		190
Aux. Sheave	1		350
Aux. Sheave (2 Sheaves)	1		450

Weights and Dimensions of Disassembled Units

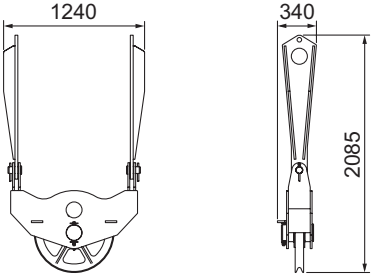
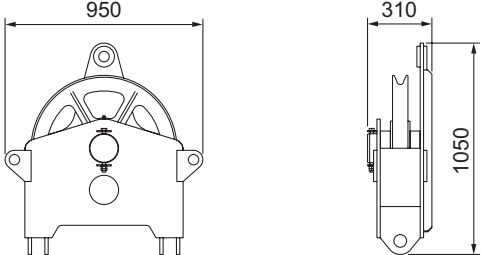
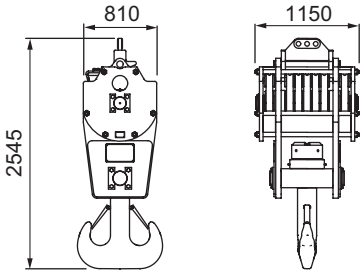
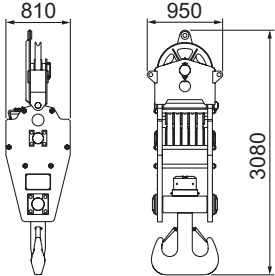
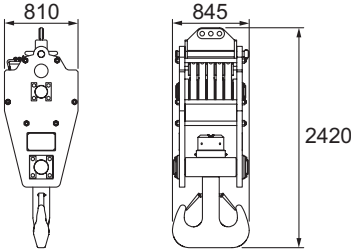
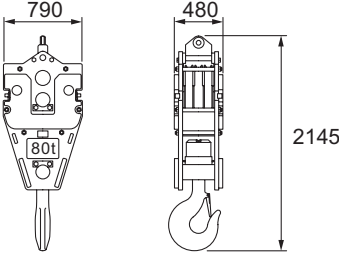
Description	Qty	Dimensions (mm)		Weight (kg)
Boom Top Side Spreader	1			430
Hook Side Spreader	1			240
175 t Hook	1			3340
160 t Hook (135 t Hook + Hook Side Spreader)	1			2590
135 t Hook	1			2350
80 t Hook	1			1350

Weights and Dimensions of Disassembled Units

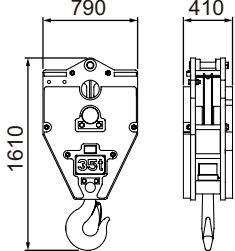
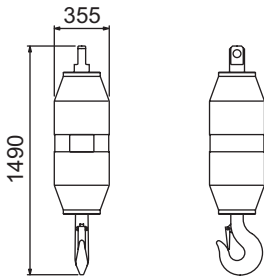
Description	Qty	Dimensions (mm)	Weight (kg)
35 t Hook	1		1070
13.5 t Hook	1		620

Equipment List

Standard and Optional Equipment

○ : Standard ● : Optional

Item		Crane
Lower Structure	1120 mm Shoe	○
	Jack Up Unit	○
	Crawler Side Frame Connecting Unit	○
	Steps	○
	Shoe Tension Unit (Hydraulic Type)	●
Upper Structure	Cab Up/Down Catwalk	○
	Under Cover (Bed Lower Surface)	○
	Working Light (× 2)	○
	Back Mirror (Left and Right)	○
	Central Lubrication Unit (For Turntable Bearing)	○
	Drum Flange Cover	○
	Auto Idle Stop	○
	Eco Winch	○
	Drum Light (Front Winch)	●
	Winch Rope Retainer (Front Winch)	●
	Winch Rope Retainer (Rear Winch)	●
	Catwalk (Folding Type, Left and Right, with Handrails)	○
	Electric Fuel Pump	●
	Electric Urea Pump (For Machine Equipped with Stage V Engine)	●
	Upper House Handrail (Folding Type)	○
Winch with Front and Rear Free Mechanism (With the Brake Mode Switch)	○	
Cab	Air Conditioner	○
	Sunvisor	○
	Sunshade	○
	Wiper with Washer (Front Window, Cab Roof Window)	○
	Microphone & Loudspeaker	●
	AM/FM Radio (With Clock)	○
	Room Lamp	○
	Cup Holder	○
	24-V Power Socket (× 2)	○
	Floor Carpet	○
	Level Gauge (In Cab & Lower Structure)	○
	Accelerator Pedal (Right)	●
	Arm Chair Lever	○
	Cross Operation Lever (Lever Lock Not Attached) *1	●
	Front Operation Lever (Lever Lock Attached)	●
	Standard Seat	○
	Suspension Seat	●
	Travel Operation Pedal (Cannot be installed when winch with free mechanism attached)	●
	Boom Hoist Operation Pedal *2	●
	Swing Brake Operation Pedal *2	●
	Fire Extinguisher	●
	Front/Rear Operation Lever, Brake Pedal Permutation	●
	Fuel Burning Heater (Light Oil)	●
	Accelerator Grip	○
	Drum Rotation Sensor (Front/Rear/Boom Hoist) *3	○
	Speed Control Dial (Front/Rear/Boom Hoist/Swing)	○
Life Hammer	○	

*1 Cross operation lever can operate front, rear, boom hoist, and swing.

*2 Cannot be installed at the same time.

*3 Cannot be equipped when the cross operation lever or front operation lever is installed.

○ : Standard ● : Optional

Item		Crane	
Booms and Hooks	175 t Top Boom (4.5 m)	●	
	160 t Top Boom (7.5 m)	●	
	7.5 m Boom Base	○	
	3 m Boom Insert	●	
	6 m Boom Insert	●	
	9 m Boom Insert	●	
	Parts Set for 13 m Crane Jib [13 m Basic Jib, Anti-Two Block, Jib Mast]	●	
	6 m Crane Jib Insert	●	
	Midpoint Pendant Rope (Required when the boom length is 78 m or longer)	●	
	Auxiliary Sheave [Including Auxiliary Sheave, Anti-Two Block]	●	
	2 Auxiliary Sheaves [Including Auxiliary Sheave, Anti-Two Block]	●	
	Boom Top Side Spreader (Only for 160 t Lifting)	●	
	Hook Side Spreader (Only for 160 t Lifting)	●	
	175 t Hook (7 Sheaves)	●	
	160 t Hook (6 Sheaves)	●	
135 t Hook (5 Sheaves)	●		
80 t Hook (3 Sheaves)	●		
35 t Hook (1 Sheave)	●		
13.5 t Hook	●		
Wire Rope	Front Winch (φ 28)	○	
	Rear Winch (φ 28)	P · S (19) + 39 x P · 7	●
		Mono Rope EP 3 x F (40)	●
	Boom Hoist Winch (φ 22.4)	IWRC 6 x P · WS (31)	○
Safety Device	Moment Limiter (M/L)	○	
	3 Color Percentage Indicator	●	
	Gate Lock Lever	○	
	Individual Winch Operation Lever Lock (Front, Rear, Hoist, Travel) *4	○	
	Automatic Drum Lock (Boom Hoist)	○	
	Winch Drum Lock (Front, Rear)	○	
	Lowering Limiter (Winch Drum Dead Turns Detective Device)	●	
	Swing Lock	○	
	Swing Alarm	○	
	Travel Alarm	○	
	Auto Slowdown (Slow Stop)	○	
	Boom Hoist Limiting Device	○	
	Secondary Boom Hoist Limiting Device	○	
	Warning Alarm	○	
	Monitor	○	
	Engine Start Interlock System	○	
	Emergency Engine Stop Switch (In Cab)	○	
	Lifting Height Indication Device	○	
	Anti-Two Block	○	
	Moment Limiter (M/L) Mode Selector (In Left House)	●	
Swing Restriction Unit	●		
Anemometer	○		
Obstacle Light (Fixed Lights)	●		
Drum & Rear View Monitor System	●		
Cab Roof Window Guard	●		

*4 An operation lever lock is not attached to the front, rear or hoist when the cross operation lever is installed.

○ : Standard ● : Optional

Item		Crane
Common Parts	Boom Foot Pin Removal/Installation Cylinder	●
	Boom Back Stop	○
	Boom Angle Sensor	○
	Boom Lifting Piece	○
	Remote Sensing (Mobile Communication Terminal, Logging Device)	○
	Assembly Pad	● ^{*5}
	Reduction Counter Weight Specification	● ^{*6}
	Skywalk (With Stanchion)	●
	Skywalk (Without Stanchion)	●
	Boom Top Under Surface Buffer (Protector)	●
	Load Table Sign (Whiteboard, Boom Base Installation)	●
	Insertable Company Name Plate (Both side surfaces of the machine)	●
	Reeving Winch (4 × F (30) φ 8 mm × 250 m)	● ^{*7}
	Sling Ropes for Disassembly and Assembly (For Counter Weight and Crawler)	●
Additional Spare Parts (Hydraulic Oil Filter)	●	
Additional Tools (Large Hammer, Crowbar, Chisel)	●	
Others	Standard Supplied Tools	○
	Standard Spare Parts	○

*5 The assembly pad is required for the following attachments.

	W/o Skywalk	With Skywalk
Main Boom	84 m	81 m
Main Boom with Auxiliary Sheave	78 m	78 m
Main Boom + Crane Jib	72 m + 25 m	72 m + 25 m
	72 m + 31 m	72 m + 31 m

*6 The reduction counter weight specification can only be used for the crane specification, with the exception of the crane jib.

*7 Reeving winch (Maximum line pull: 11.8 kN (1,200 kg))



A series of horizontal dashed lines for writing, spanning the width of the page.

- We are constantly improving our products and therefore reserve the right to change designs and specifications without notice.
- Units in this specification are shown under International System of Units; the figures in parenthesis are under Gravitational System of Units as old one.

Sumitomo Heavy Industries Construction Cranes Co., Ltd.

9-3, Higashi-Ueno 6-chome, Taito-ku, Tokyo 110-0015, Japan
Phone: 81-3-3845-1387 Facsimile: 81-3-3845-1394

<http://www.hsc-cranes.com>