

General dimensions

Units: mm

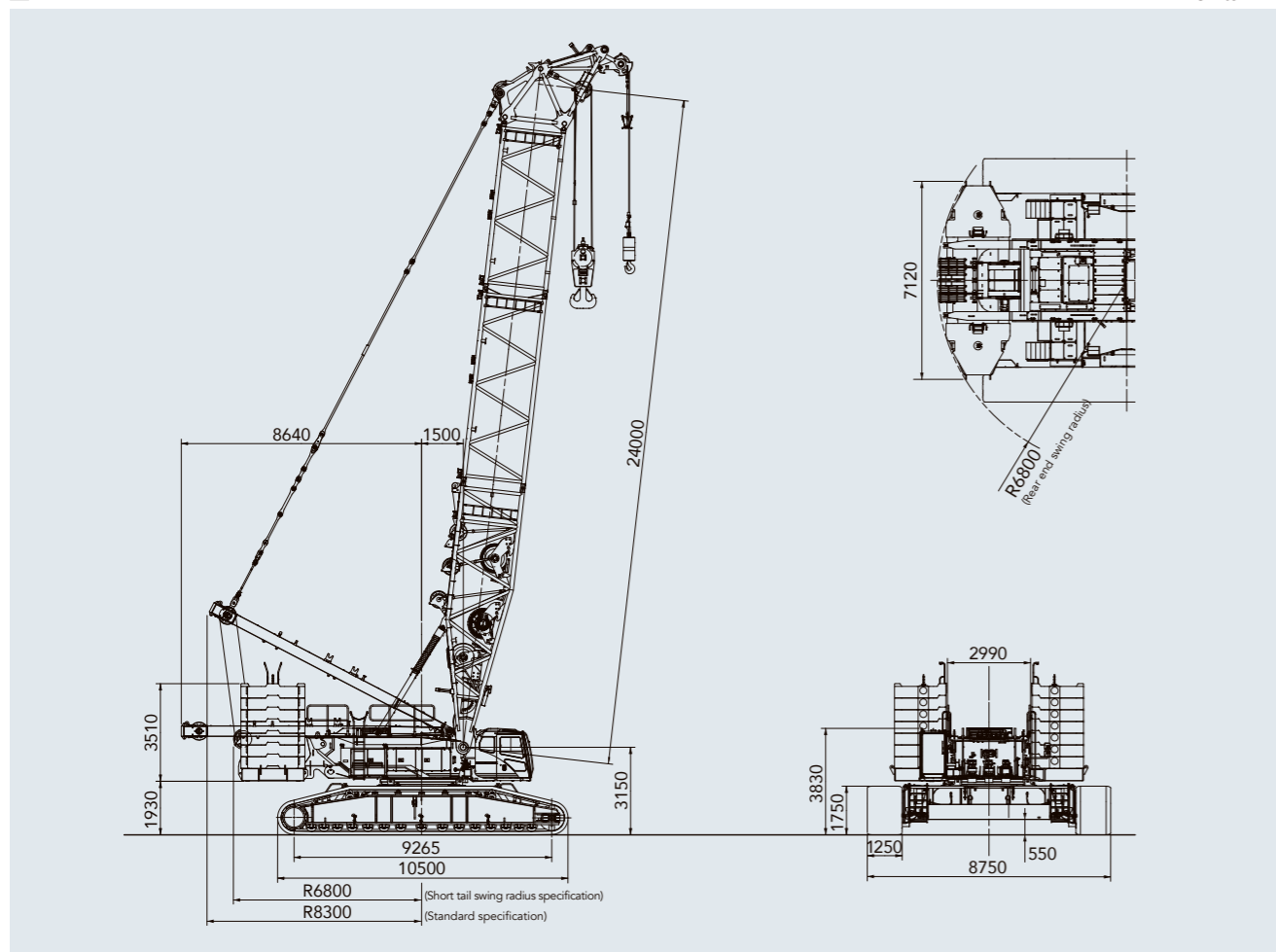

Specifications

Model		SCX3500-3		
Application		Liftcrane		Luffing Towercrane
		With Hammer Head	With Boom Top	
Max. lifting capacity	t × m	350 x 5.0	180 x 10.0	100 x 12.4
Basic boom length (with Hammer Head)	m	18	—	—
Basic boom length (with Boom Top)	m	—	24	—
Max. boom length	m	18	72	—
Tower length	m	—	—	24~60
Tower jib length	m	—	—	24~60
Tower + tower jib length	m	—	—	60 + 60
Rope line speeds (*1)	m/min			
Front/rear main drum	m/min	110	110	110
Boom hoist drum	m/min	34 x 2	34 x 2	34 x 2
Tower jib hoist drum	m/min	—	—	55
Swing speed	min <sup>-1</sup> (rpm)	0.86 (0.86)	0.86 (0.86)	0.86 (0.86)
Travel speed high/low(*2)	km/h	0.9 / 0.45	0.9 / 0.45	0.9 / 0.45
Gradeability	% (°)	30 (17)	30 (17)	30 (17)
Engine	Make & model	Cummins QSL9 (Stage IV / Tier 4 f)		
	Rated output	kW/min <sup>-1</sup> (PS/rpm)		
		272/2,000 (370/2,000)		
Ground contact pressure	kPa (kgf/cm <sup>2</sup> )	136 (1.39) With 18 m boom and 350 t hook	135 (1.38) With 24 m boom and 180 t hook	152 (1.55) Maximum tower + tower jib length 100 t hook & 15 t hook
Operating weight	t	321 With 18 m boom and 350 t hook	320 With 24 m boom and 180 t hook	360 Maximum tower + tower jib length 100 t hook & 15 t hook

Notes: 1. Rope line speeds vary under load and operating conditions (\*1). 2. Travel speed is based on flat, level and firm supporting surface with no load and 18 m basic boom (\*2).

- We are constantly improving our products and therefore reserve the right to change designs and specifications without notice.
- Units in this catalog are shown under International System of Units (SI). The figures in parenthesis are under the older British Gravitational System of Units.
- Illustrations may include optional equipment and accessories, and may not include all standard equipment.
- Standard equipment and accessories may vary by country and region.

Sumitomo Heavy Industries Construction Cranes Co., Ltd. has been abbreviated as "HSC" throughout this catalog. "HSC CRANES" is a brand of Sumitomo Heavy Industries Construction Cranes Co., Ltd.

Address inquiries to :

Sumitomo Heavy Industries Construction Cranes Co., Ltd.  
 9-3, Higashi-Ueno 6-chome, Taito-ku, Tokyo 110-0015, Japan  
 Phone: 81-3-3845-1387 Facsimile: 81-3-3845-1394  
<http://www.hsc-cranes.com>

Printed in Japan  
 2009©05H.EA368

**SCX**  
**3500-3**







## Towards a New Stage of Innovation.

Working today to shape tomorrow, by building a brand new global outlook.

Seeking a new level of performance for 350 t class crawler cranes.

Outstanding work capabilities within a refined compact body,  
combined with unsurpassed transportation and assembly efficiency.

Designed with the eco-performance and fuel efficiency required for the future,

coupled with exceptional safety and operability. High-performance to make

any job a breeze, with a level of sophistication for safe and secure working conditions.

Introducing the new SCX3500-3, offering the functions required for shaping tomorrow.

With power to impress, the SCX3500-3 will further boost momentum in a rapidly changing world.

# SCX 3500-3



The Good Design Award has been granted to the "SCX-3 Series" for its superb operability, ease of transportation and assembly, safety, and eco-friendly performance as a new generation of crane.





## SCX3500-3 PERFORMANCE

### High-performance and compact. Operating capabilities to suit any worksite.

As a new generation of crane, the goal was to develop operating performance to meet any worksite, and comply with any requirement there. The SCX3500-3 is built on a compact body with a high level of performance, ensuring operating capability in tight spaces while also covering a wide range of work areas. As a crane catering to diverse work requirements, the SCX3500-3 is designed from the ground up to make jobs even easier.

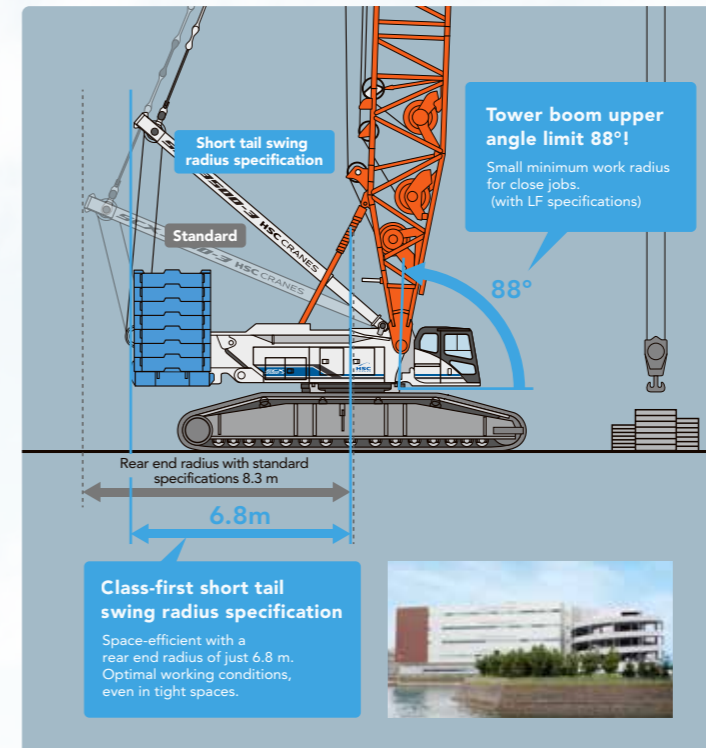

#### Class-first short tail swing radius specification

The first short tail swing radius specification for the 350 t crane class is available as an option with the SCX3500-3. This allows for smoother operations by reducing the mast overhang when hoisting or lowering the boom. The same 6.8 m rear end swing radius as the counter weight model means greater versatility on tight worksites. The short tail swing radius specification is available by simply changing over the bar pendant. A moment limiter provides automatic detection in this configuration for peace of mind. (Note) Certain areas of performance differ to the standard specification.

#### Compact body for a wide range of jobs

Performance of a 350 t class crane in the smallest body in its class. The SCX3500-3 is capable of work over a large radius just like its predecessors, and also makes operations close to the crane easier during luffing jobs, by limiting the angle of the tower boom to 88° and tower jib to 74°. Versatility with jobs over a small radius as well as a large radius helps to increase productivity.

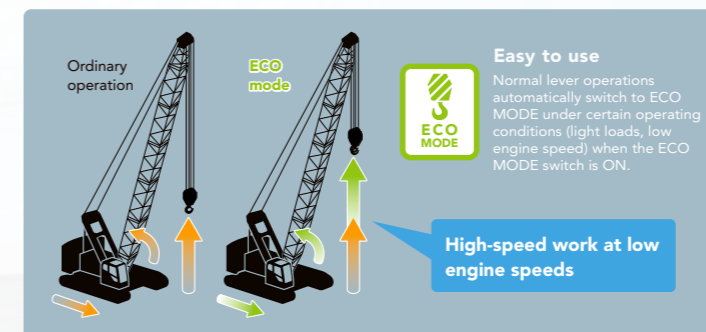

#### ECO MODE

ECO mode is included, which allows high-speed lifting and lowering, as well as boom hoisting and traveling when working with light loads without having to increase the engine speed. This delivers excellent efficiency on high-elevation construction sites or work requiring many wire rope replacements, as well as limiting fuel consumption and noise as engine speed can be kept at a minimum.



Swing mode selector switch

#### Swing neutral brake standardization

During work requiring the cab to swing (when the swing lever is in the neutral position), the operator may choose between free or brake mode depending on the work and personal preferences, making operations so much smoother.



## SCX3500-3 CONTROL

### High-precision jobs, exactly as planned. Reliable control for more peace of mind.

A higher rigidity body and boom, combined with a lighter tower jib has resulted in drastic improvements to swing operations. The crane can be operated smoothly exactly as the operator would expect, for a supreme level of control. This takes the crane's core operations of lifting and traveling to brand new heights.



#### High-rigidity body and boom for unparalleled precision and handling

In addition to greater rigidity for the lower frame, boom rigidity has also been increased with the use of a wider boom foot and larger diameter boom material. This higher level of rigidity provides an outstanding level of control for high-precision and dependable operating capabilities. The result is faster hoisting and positioning of loads, with minimal side deflection and twisting at the front of the crane. The mast system ensures a more responsive feel when using the hoisting levers.



#### Control dials

Fine speed control dials for operations such as hoisting, lowering, swinging and boom hoisting are positioned in a central location on the left side console. Operations can be adjusted at will to suit the particular job.

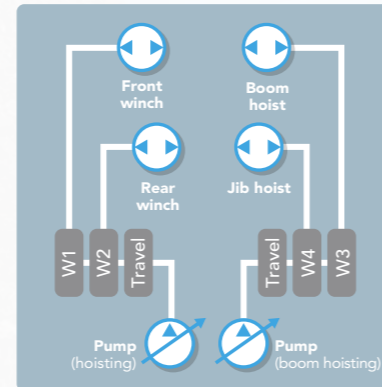

#### Improvements to combined control

Separating the hydraulic circuits for hoisting and boom hoisting by using two pumps eliminates interference when hoisting loads or hoisting the boom at the same time, ensuring maximum performance. Pump tilt is controlled individually to suit the particular job, which limits speed changes when loads increase when using combined control, for more predictable operation. This also reduces the engine load and helps to cut back on fuel consumption.



Left: Boom hoist operation pedal  
Right: Swing brake operation pedal

#### Swing brake operation pedal **OPTION**

A swing brake operation pedal is available to ensure precise swing control under strong-wind situations. This allows brake control to be applied when swinging the cab around, resulting in precise swing control even on the harshest of worksites.

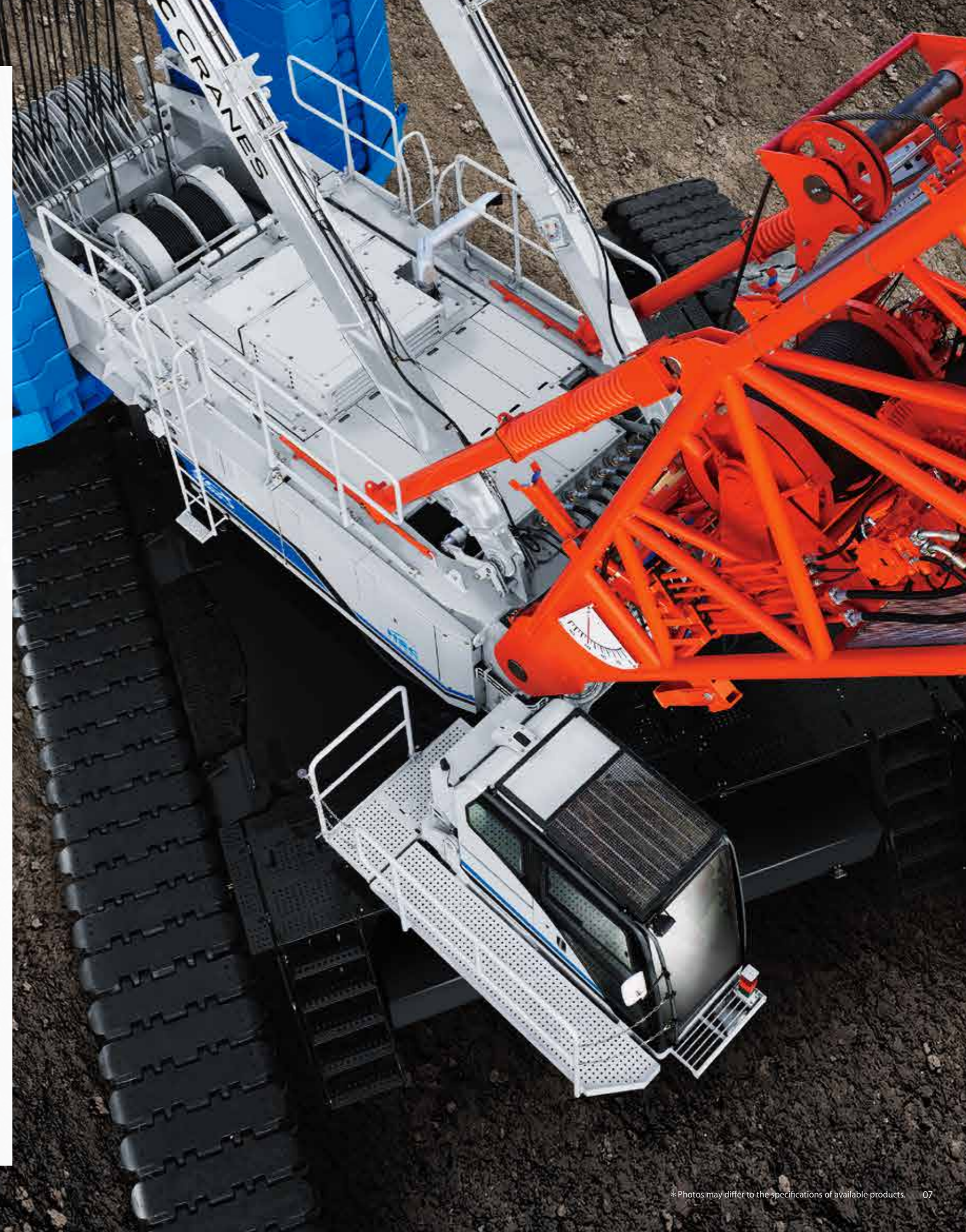





\*Photos may differ to the specifications of available products.

## SCX3500-3 TRANSPORTABILITY

### Easier self-assembly. Superb transportability brings greater efficiency all around.

The SCX3500-3 offers exceptional performance and a streamlined assembly system to suit a diverse range of worksites. The transportation and self-assembly system has been designed to reduce transportation costs, shorten assembly time and improve work safety to deliver a higher level of efficiency at any worksite.

#### Reducing transportation costs with a transportation width less than 3 m

A transportation-friendly body size has been used to cater to changing transportation requirements. With a body width of less than 3 m and a total weight of 32 t, the SCX3500-3 also has a lower frame length of 6.05 m is to suit the size of standard drop-deck trailers.

#### Front-rear split frame

The crane body (upper structure) can be separated into front and rear sections. The rear frame features a single mast and boom hoist winch structure, eliminating the need to remove any hoisting wires. Installation and removal of the front and rear frames uses a hook-on and pin joint system (hydraulic assist pin) for easy positioning, which in turn makes work faster and safer.



#### QuickDraw system OPTION

A QuickDraw system is available for self-installation/removal of the heavy crawler side frame, boom base and lower weights. By using QuickDraw system, assembly work can be done by helper cranes used to install counter weight. Other assembly work can also proceed at the same time, further increasing work efficiency.

#### Foldable type tower jib assembly

The tower jib can be assembled on small worksites. The assembly process can also be completed with the tower jib beneath the boom.

\* The foldable type is available when the tower jib is shorter than the boom.

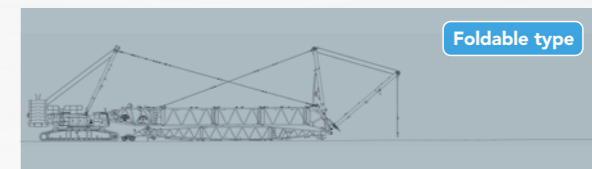

Foldable type

#### Bar pendant

The bar pendant system is not as affected by twisting or extension and retraction operations, and allows for easier connections and storage within the boom.

\* The jib pendant is a rope-based system.

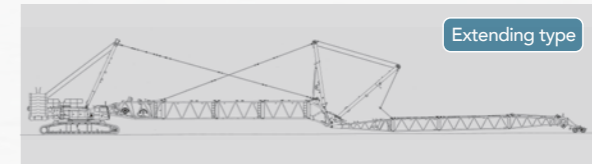

Extending type

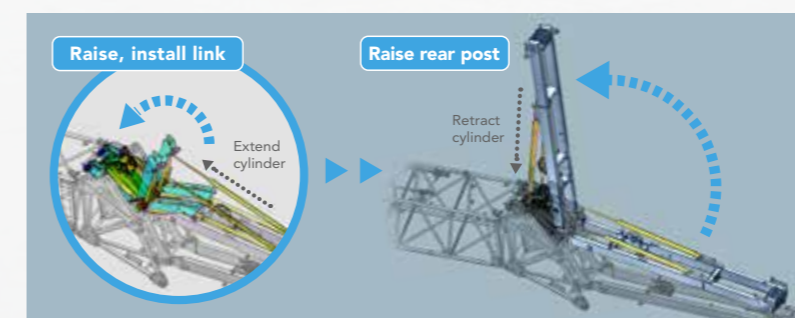

#### Hydraulic rear post backstop

The rear post required for luffing tower crane work can be raised hydraulically. Tower cranes are no longer required for the hoisting stages, which means safer, more accurate operations. Extending the hydraulic cylinder makes it easier to connect and tension the pendant for supporting the rear post, which drastically reduces assembly time.

#### Designed for ease of transportation and assembly

- [Transportation] ● Winch mounted within boom ● Swing cab mechanism ● Boom insert with easier transportation
- [Assembly] ● Multi-assembly stage monitoring system ● Hook-on and pin joint system mast
- Laterally symmetrical counter weight shapes ● Boom connection pin holding device
- Pendant rope holding device ● External hydraulic pump connection for assembly/disassembly OPTION



## Reliable and precise. Advanced safety features for the unexpected.

Improving safety should come first and foremost. A simple, easy-to-view interface has been designed to ensure that information is provided to the operator in the most reliable way possible. Various accident prevention functions and multiple redundant safety devices have also been installed for protection against the unexpected. Work is covered by the utmost safety and reliability with a full complement of advanced safety equipment.

### Moment limiter display

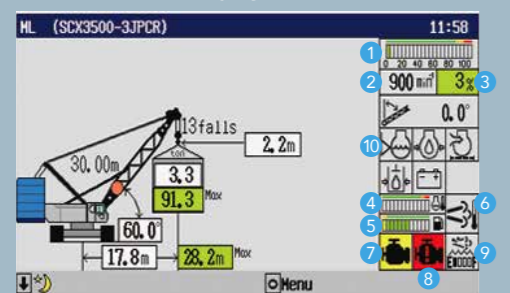

- 1 Load ratio indicator (%)
- 2 Engine speed
- 3 Load ratio (%)
- 4 Water temperature (engine coolant)
- 5 Fuel gauge
- 6 Aftertreatment device display
- 7 Engine trouble alarm (yellow)
- 8 Engine trouble alarm (red)
- 9 DEF/AdBlue® gauge
- 10 Warning icons

### Moment limiter with large screen display

A large screen display has been used offering excellent visibility and field of view of any job. A host of items can be shown, while a simple display layout ensures that information is provided to the operator properly. The display has also been designed with an interactive interface to follow any movement of the crane from a safety perspective, which helps to limit unintended operations and maintain utmost safety.

### ML Anti-two block

A new anti-two block using a lifting height indication device is offered as a standard equipment. When a height restriction is set in advance in the lifting height meter, the slowdown function will kick in as the restricted height is approached to prevent hook overhoist. Together with the anti-two block switch, the lifting height moment limiter provides a redundant level of safety against hook overhoist, leading to improved safety.

Note) This function plays a supplementary role to the existing moment limiter and use of this equipment alone is prohibited by laws and regulations.

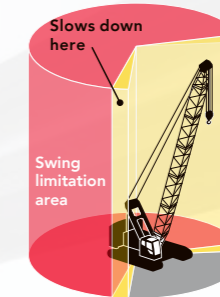

**Swing restriction unit** OPTION  
 The swing restriction unit prevents the crane from swinging into objects by allowing the swing range to be preset, and notifying the operator of the swing range and automatically stopping the crane when required. Together with the restricted swing range function, the result is an added level of safety when working in tight areas.



Rear view monitor camera

**Drum and rear view monitor system** OPTION  
 A drum and rear view monitor system is available as an optional extra to help operators better oversee the condition of the winches. Switchable cameras also make checking each section of the crane easier.

### Designed for safe work

An auto drum lock is included as standard to detect boom hoisting operations and automatically apply the lock when the lever is in the neutral position. Various warning alarms and data are conveyed to the operator and others nearby with the aid of audible alarm functions to reduce the number of careless accidents. Handrails (inserting type) are also installed as standard, to ensure work is conducted as safely as possible.

### Flat, wide body design

The swing frame and crawler upper level height can be arranged flat, and gaps covered with footplates to provide a spacious area to walk on, for added safety.



Flat work area for added safety

### Other safety functions and devices

- Winch drum lock (front, rear)
- Individual winch operation lever locks
- Three color percentage indicator OPTION
- Anti-two block
- Emergency engine stop switch
- Gate lock lever
- Handrail (inserting type)
- Auto slowdown device



**Enhanced visibility and smooth operations for greater comfort peace of mind.**

Designed to make the stressful job of operators, more stress-free and more comfortable. Excellent visibility is just the start, and with easy-to-use accessories and an ergonomic control layout, the SCX3500-3 is designed to make things smooth. These all help to reduce operator fatigue, while at the same time increasing comfort and functionality for maximum performance, day-in, day-out.



**Better visibility in all directions**

The cab has extra-wide windows to improve visibility in all directions. Green tinted safety glass has been used all round to protect the operator from UV rays and objects that may have come free during operation. The wipers now sweep a greater area to make work easier, even when working in rain.

Photos may differ to the specifications of available products.



**Highly-functional seat for optimum work position**

The new seats are designed with the ideal shape for a more comfortable seating position. The wide range of seat adjustments means it suits any body shape, for the best work and a relaxing posture. A seat with suspension is available as an optional extra.

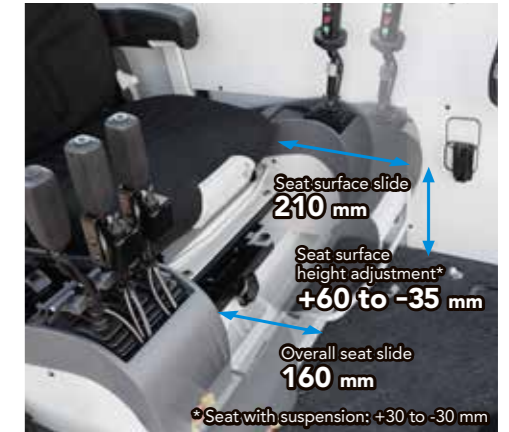

Wide range of seat adjustments



Full-flat design for resting



**Tilt cab for better operator visibility**

The SCX3500-3 comes with a cab tilt mechanism that allows the cab to tilt back up to 15° to make moving loads at heights easier. The optimum work position suited to the job ensures the best possible operator visibility.

**Various items for more comfortable work**



Up/down steps



Wipers with greater sweep area



Sunshade

**Control levers with drum rotation sensor**

Control levers are designed for better operation with optimization made to the pitch, and a winch drum rotation sensor is also included. Any rotation in the winch is conveyed to the operator via the levers, for full control required for precision hoisting jobs. The result is smooth winching where accuracy is vital, such as positioning bolts with the crane.



**Upper cabin controller**

Controllers for the wipers, work lights, drum lock and other functions have been installed higher up near frequently used controls for a more natural layout.



**Useful and functional interior accessories**



Outside-air intake air-conditioner



Cup holder



AM/FM radio (with clock)



Storage shelf



**The highest level of clean performance.  
Environmentally-friendly design to redefine mankind and society.**

It is fitting that the most advanced technology is installed in a machine designed to redefine the future of society. The SCX3500-3 brings together a new cleaner running engine and advanced control system (ECO mode, auto idle stop function) for energy-efficient operation. One of the first models to meet EU Stage IV/U.S. Tier 4 Final exhaust gas emission regulations, the SCX3500-3 also offers exceptional fuel efficiency and outstanding operation and control.



**CUMMINS QSL9**

Displacement: 8.849 L  
Rated output: 272 kW (370 PS)/2,000 min<sup>-1</sup>  
Max. torque: 1,627 N·m (166 kgf·m)/1,500 min<sup>-1</sup>



**New clean engine**

The new clean engine featuring the advanced eco technology "Urea SCR System" was one of the first in the industry to meet EU Stage IV/U.S. Tier 4 Final exhaust gas emission regulations. Compared to the previous model (Stage III A/ Tier 3), emissions of NOx (nitrogen oxides) and PM (particulate matter) have both been reduced by approximately 90%. In addition to the lowest level of exhaust gas emissions, lower fuel consumption also helps to cut down on CO2 emissions. The SCX3500-3 represents the path of evolution into a more eco-friendly machine.

**Clean performance (JPN)**

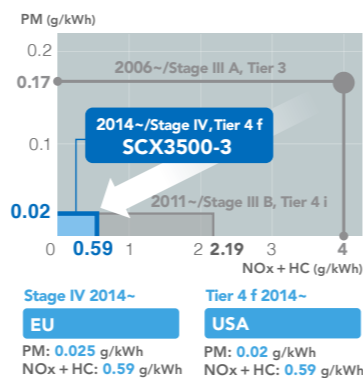

Urea tank

**Urea SCR System**

An exhaust gas aftertreatment device that injects AdBlue® (urea fluid) into the exhaust gas to break down NOx gases into harmless water and nitrogen via a chemical reaction. Treating the NOx in the exhaust helps to maintain the engine's high combustion efficiency and improve fuel efficiency and power output.

AdBlue® is a registered trademark of the German Association of the Automotive Industry.



**Maintenance-free operation**

The Urea SCR System does not include an internal ceramic filter for removing PM, as the high-efficiency combustion of the engine minimizes PM generation. Simply refilling with AdBlue® eliminates the need for any further maintenance on the exhaust system that could affect operations, for a high level of practicality with day-to-day work.

**Precautions with the new clean engine** Always use diesel for the fuel, specified lower ash oil (DH-2 <JASO>, CJ-4 <API> class) for the engine oil, and specified engine coolant. The Urea SCR System may undergo automatic regeneration (cleaning) to maintain its performance level.

**Other fuel efficiency technology**



Minimizes excess fuel consumption during work  
**Auto idle stop function**



Reducing wastage during light load work, increasing productivity  
**ECO mode**  
(see page 5 for details)

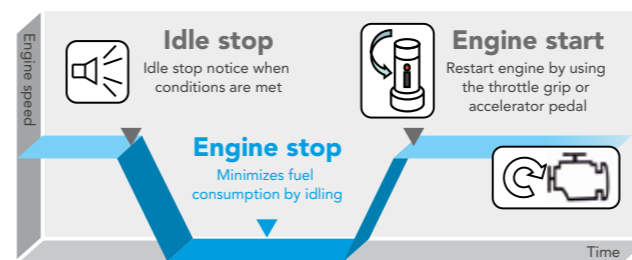

A new auto idle stop function is available for energy-efficient operation and minimal exhaust gas emissions. This prevents unnecessary idling during work to help reduce fuel consumption and limit the level of wear throughout various components. There is no impact on work, as the function stops the engine if the switch is ON and the required conditions are met, and restarts the engine when the accelerator is used.



Fuel economy has been improved drastically when winching up and down with light loads. This design ensures energy-efficient operation over repetitive movements or working with loads at heights.

**Variable capacity pilot pump**

A variable capacity pilot pump has been used to maintain operating pressure. The pump provides the required flow rate to maintain a constant pressure, which limits unnecessary loss while the crane is waiting, and thereby help reduce fuel consumption.



# Excellent support and peace of mind for ongoing work.

## Advanced eco technology "Urea SCR System"

The SCX3500-3 uses the advanced eco technology "Urea SCR System" to meet the latest exhaust gas emission regulations. The Urea SCR System offers the benefits of low-emission gas and low fuel consumption, while better fuel efficiency also helps to prevent global warming (by reducing CO<sub>2</sub> emissions).

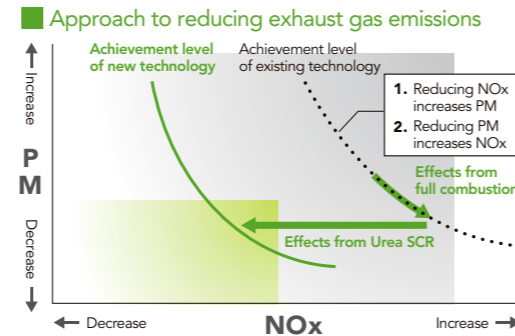

## Urea SCR System design

- 1 Reduces fuel consumption and limits PM generation with high-efficiency engine combustion
- 2 Oxidizes HC (hydrocarbons) and CO (carbon monoxide) from the engine with an oxidation catalyst
- 3 Injects AdBlue® into the exhaust gas. Breaks down NO<sub>x</sub> to harmless water and nitrogen

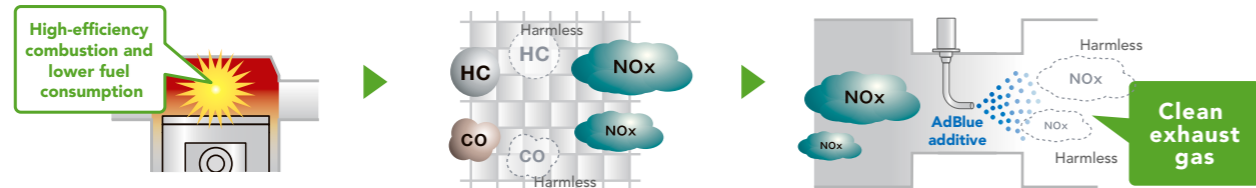

This image is to highlight the effects of the system, and has been exaggerated for illustration purposes.

## What is AdBlue®?

The trademark of a high-quality urea aqueous solution standardized in Europe for using the Urea SCR System.



AdBlue® is a registered trademark of the German Association of the Automotive Industry.

Refilling frequency  
Once per two refuelings

The SCX3500-3 requires AdBlue® to be refilled once every two times the machine is refueled. (AdBlue® consumption may vary slightly depending on operating conditions)



## Precautions with machines installed with the Urea SCR System

To ensure that the machine can be used safely and smoothly, use AdBlue® aqueous solution (or a urea aqueous solution that complies with JIS or ISO standards). Using a non-standard aqueous solution or diluting the solution before use may cause mechanical problems. Malfunctions arising from the use of non-standard aqueous solutions are not covered by the HSC warranty service.

- The remaining AdBlue® level can be checked during work on the monitor display (Moment Limiter) in the cab. A warning is displayed on the monitor when the remaining level becomes low or there is an issue with quality.
- The engine power output will be limited if the remaining AdBlue® level falls below the minimum level or there is an issue with quality, so be sure to plan refills in advance.
- The Urea SCR System is designed exclusively for the machine, and must not be used for any other purpose.
- Rinse with water any solution that comes in contact with skin.
- When storing the solution, always use sealed containers and store at room temperature in a well-ventilated location out of direct sunlight. When carrying the solution, always use the container that the solution was purchased in, or other specified container.
- The Urea SCR System includes a heater function, however sufficient care must be taken to prevent freezing when the solution is stored in cold regions (freezing temperature: -11°C)
- Read the instruction manual for more details.

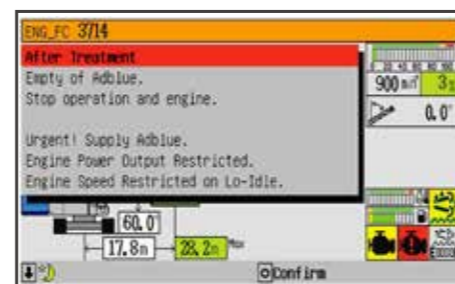

Example monitor warning display

## REMOTE SENSING

### "REMOTE SENSING" system installed as standard

Precise monitoring of the crane's operating condition to minimize downtime and ensure accurate maintenance. Keeping machines in the best possible operating condition helps to improve operating efficiency, while also reducing the time and cost required for maintenance.

Store data on machine conditions and operations, remote management

(total operating time management, position information with GPS, operating condition management such as work conditions)

Minimize downtime

Accurate maintenance

Better safety

### Image of REMOTE SENSING

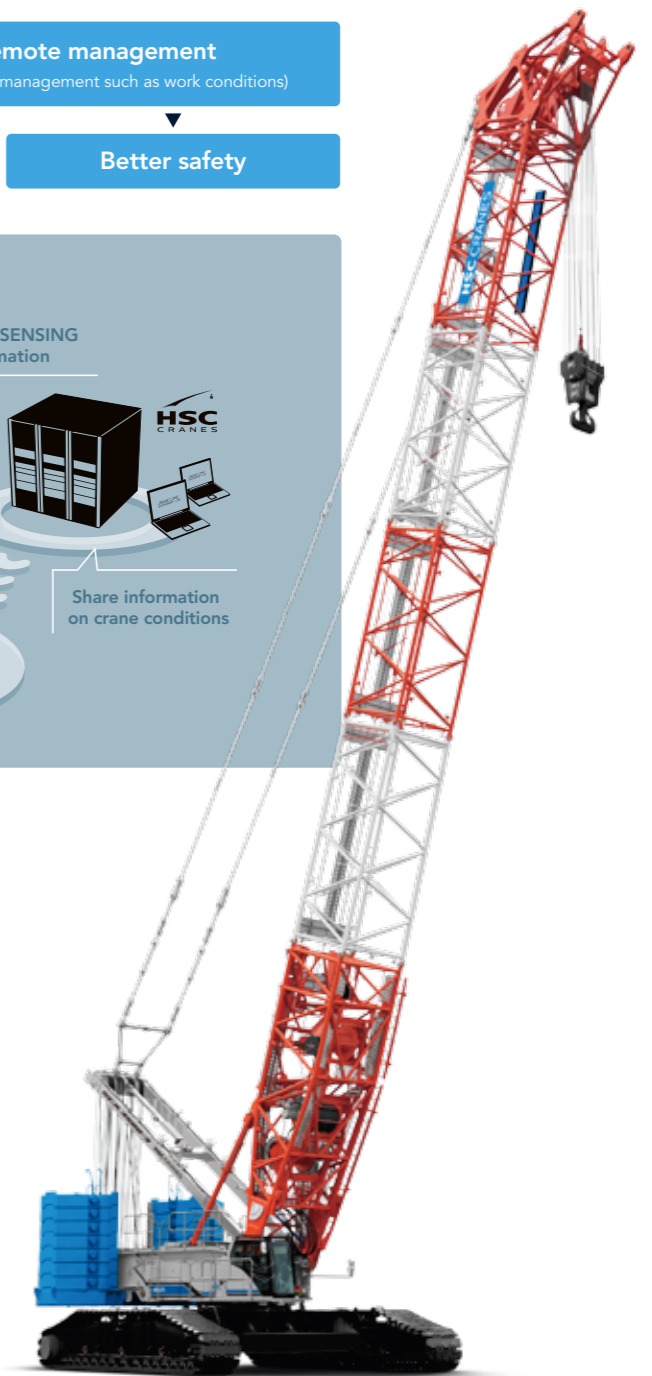

\*Photos may differ to the specifications of available products.





## Professional SCX3500-3

Supporting future development, building a new age.  
The SCX3500-3 masters new potential to provide a future for all.